













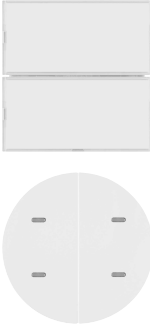













<b>Application description</b>	
--------------------------------	---

























KNX push-button 1, 2, 3 and 4gang

*Electrical/mechanical data: see the operating instructions for the product*

	<b>Order number</b>	<b>Product designation</b>	<b>Application programme</b>	<b>TP product </b> <b>Radio product </b>
	8014 13 XX 8016 17 XX 8016 18 XX	KNX push-button 1gang		
	8014 23 XX 8016 27 XX 8016 28 XX	KNX push-button 2gang		
	8014 33 XX 8016 37 XX	KNX push-button 3gang		
	8014 43 XX 8016 47 XX	KNX push-button 4gang		

## Table of contents

<b>1. General</b> .....	<b>4</b>
1.1 General information about this application description .....	4
1.2 Programming software configuration tool.....	4
1.3 Commissioning.....	4
<b>2. Functional and device description</b> .....	<b>5</b>
2.1 Device overview .....	5
2.2 Functional description .....	6
2.3 Operating concept.....	6
2.3.1 Operating instructions.....	8
2.3.2 Range of functions.....	8
2.4 Functional overview .....	9
2.4.1 No function  .....	9
2.4.2 Lighting .....	9
2.4.3 Dimming.....	10
2.4.4 roller shutters .....	11
2.4.5 Heating/cooling .....	12
<b>3. Project preparation</b> .....	<b>13</b>
3.1 Project editing .....	13
3.2 Device choice.....	14
3.2.1 Menu field - parameters.....	14
3.3 Overview inputs/outputs.....	16
3.4 Parameterisation of Status LED / backlighting.....	17
3.4.1 Function status LED.....	17
3.4.2 Backlighting  .....	17
3.4.3 Switch off device LEDs  .....	18
<b>4. Configuration independent push-button</b> .....	<b>19</b>
4.1 Functions Lighting .....	20
4.1.1 Functions On  / Off  .....	20
4.1.2 ON/OFF functions (buttons).....	21
4.1.3 Toggle switch function.....	21
4.1.4 Timer function  .....	21
4.1.5 Functions priority toggle On  / Off  .....	22
4.1.6 Scene function  .....	23
4.1.7 Automatic control deactivation toggle  .....	24
4.1.8 Overview of all possible linking combinations.....	25
4.2 Dimming functions.....	27
4.2.1 Functions Dimming Up (ON)  / Down (Off)  .....	27
4.2.2 Functions Dimming Up/Down  .....	27

4.2.3	Function Dimming 	28
4.2.4	Scene function 	28
4.2.5	Automatic control deactivation toggle 	28
4.2.6	Overview of all possible linking combinations	29
4.3	Roller shutter function	30
4.3.1	Basis roller shutter/blind control	30
4.3.2	Functions blinds up  / blinds down 	33
4.3.3	Function roller shutter position 	33
4.3.4	Function slat angle 	34
4.3.5	Functions Roller shutter and slat position 	34
4.3.6	Functions roller shutter up  / roller shutter down 	35
4.3.7	Functions Priority up toggle  / down toggle 	35
4.3.8	Scene function 	36
4.3.9	Automatic control deactivation toggle 	36
4.3.10	Overview of all possible linking combinations	38
4.4	Functions Heating/cooling	40
4.4.1	Function Comfort mode 	41
4.4.2	Function Standby mode 	41
4.4.3	Function Eco mode 	42
4.4.4	Function Protection mode 	42
4.4.5	Function Setpoint offset $\pm x$	42
4.4.6	Function Priority comfort toggle 	43
4.4.7	Function Priority protection toggle 	43
4.4.8	Function Heating / cooling toggle 	44
4.4.9	Scene function 	44
4.4.10	Automatic control deactivation toggle 	44
4.4.11	Overview of all possible linking combinations	45
<b>5.</b>	<b>Temperature sensor function parameters</b>	<b>46</b>
5.1	Internal temperature sensor 	46
5.2	External temperature sensor 	47
<b>6.</b>	<b>Appendix</b>	<b>48</b>
6.1	Technical data	48
6.2	Accessories	48
6.3	Warranty	48
<b>7.</b>	<b>Table of Figures</b>	<b>49</b>
<b>8.</b>	<b>List of tables</b>	<b>51</b>

## 1. General

### 1.1 General information about this application description

This document describes the programming and parameterisation of easy compliant KNX products with the aid of the *configuration tool*.

### 1.2 Programming software configuration tool

The application programs for the KNX products are already preinstalled in the configuration tool.

- i** If the current application software is not available in the configuration tool, then the configuration tool must be updated (see "Configuration tool" installation handbook).

### 1.3 Commissioning

The commissioning process for the push-buttons refers primarily to the linking of the buttons (hereinafter inputs) and the switch actuator outputs (hereinafter outputs) as well as the selection of the respective push-button functions (switching, dimming, roller shutter/blind, etc.).

- i** The commissioning process for the configuration tool can be found in the corresponding instructions.
- i** Programming with the configuration tool is restricted to just one bus line and does not require a line coupler. As a result, it is possible to combine wired and wireless-network (quicklink ) KNX devices.

## 2. Functional and device description

### 2.1 Device overview

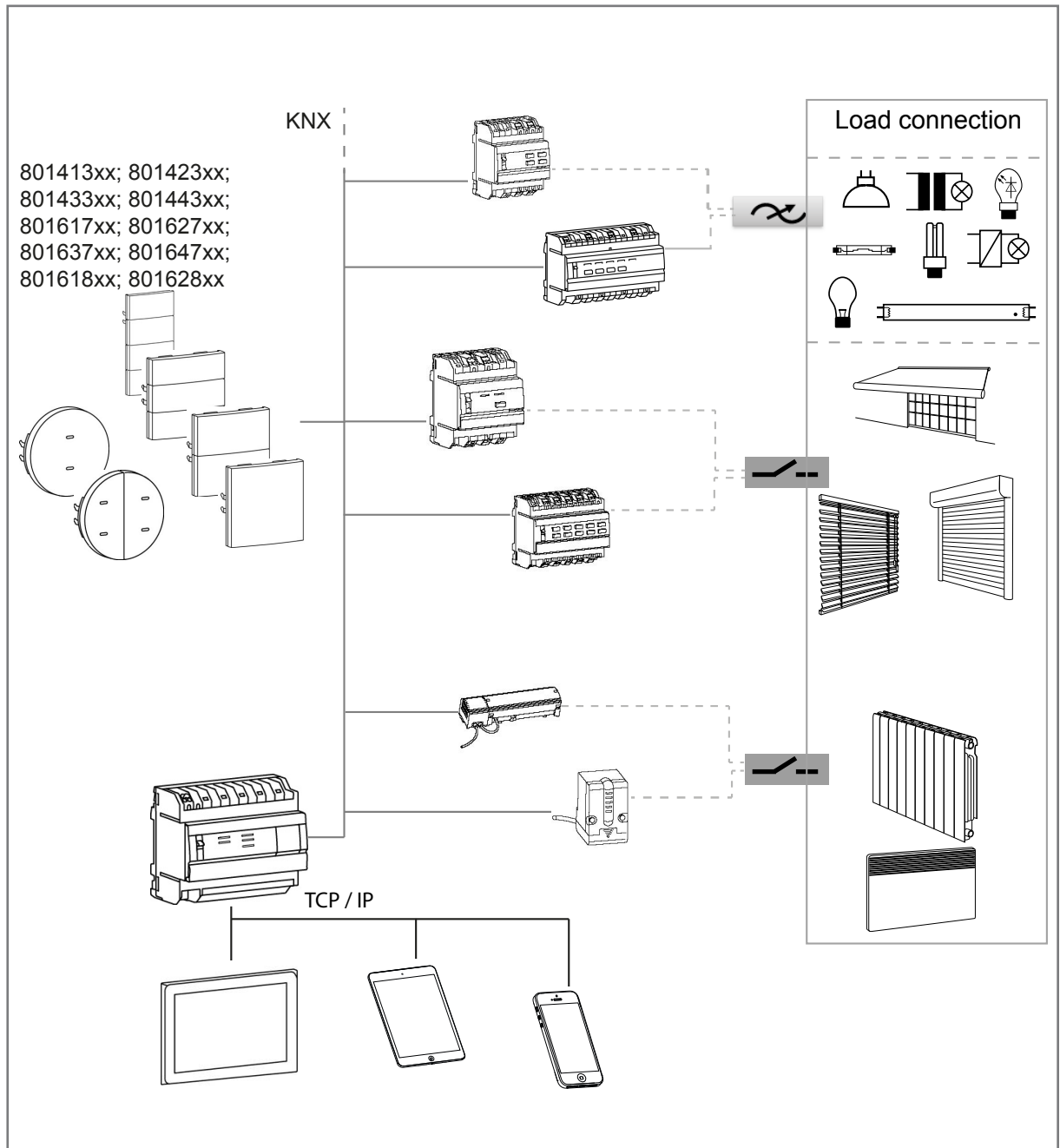

Figure 1: Device overview

## 2.2 Functional description

The devices, 1 - 4gang push-buttons, are only functional with a flush-mounted bus coupling unit (8004 00 x1). The following functions can be assigned to the inputs:

- Switching
- Dimming
- Blind/roller shutter
- Scene
- Priority
- Heating/cooling

The assignment of the various functions is freely selectable for each input and is defined by parameterisation. Depending on the parameterised functions, telegrams are transmitted to the KNX system bus. These trigger the corresponding switching, dimming, blind/roller shutter functions, open or save light scenes and set dimming, brightness or temperature values by touching the button.

## 2.3 Operating concept

The function of the individual push-buttons/inputs depends on the programming of the push-button. Depending on the version, devices are fitted with up to eight pressing points.

### Button/input

The left (1) or right (2) side are designated as input. The respective inputs can work independently of each other → single-surface operation (e.g. left button area → Roller shutter no UP/DOWN and right button area → Lighting ON/OFF) but can also work together in a single function → two-surface operation (switching lighting left on/right off).

### Arrangement of the buttons/inputs

The following view shows the order/arrangement of the buttons/inputs.

The 4gang push-button is pictured here as an example. The arrangement is identical for the 1gang, 2gang and 3gang variants. The numbers 1 - 8 correspond to those of the inputs (buttons).

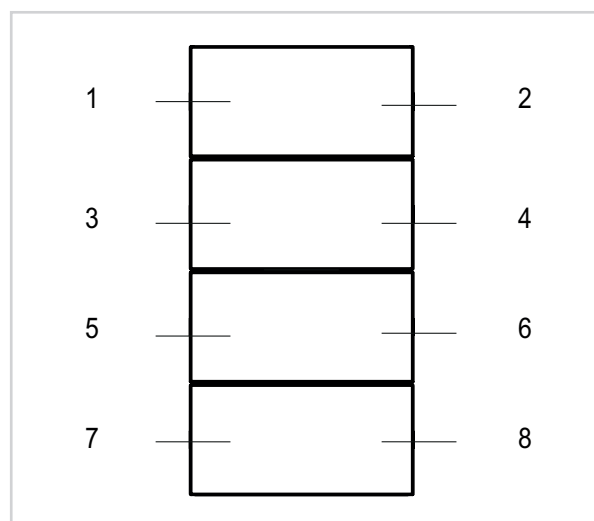

Figure 2: Button/input assignment – numbering in configuration tool S.1

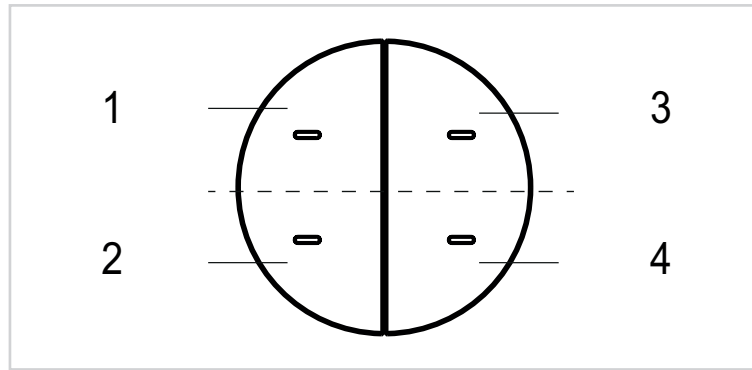

Figure 3: Button/input assignment – numbering in configuration tool R.x

### 2.3.1 Operating instructions

The device differentiates between short and long touches.

- Short touch operation
  - Switch lighting
  - Shutter/blind step operation
  - Operating mode changeover, etc.
- Long touch operation
  - Dimming the lighting
  - Move command (move) roller shutter/blind
  - Saving of a scene

### 2.3.2 Range of functions

- A function can be assigned to each button (input).
- Each individual button can be used for one function from lighting, dimming, roller shutter, heating/cooling.

#### **Lighting:**

Each button can be assigned one of the following functions: "On, Off, Switching, Toggle switch, Timer, Priority on/off toggle, Scene, Deactivate automatic control toggle".

#### **Dimming:**

Each button can be assigned one of the following functions: Dimming up (on), Dimming down (off), Dimming up/down, Dimming, Dimming (dimming value in %), Scene and Automatic control deactivation toggle.

#### **Roller shutter:**

Each button can be assigned one of the following functions: Blind/roller shutter up/down, Roller shutter position, Slat angle, Roller shutter and slat position, Priority up/down toggle, Scene and Automatic control deactivation toggle.

#### **Heating/cooling:**

Each button can be assigned one of the following functions: Comfort mode, Eco mode, Standby mode, Protection mode (frost protection), Setpoint offset, Priority comfort toggle, Priority protection toggle, Heating/cooling toggle, Scene and Automatic control deactivation toggle.

- Each button has an RGB status LED.
  - The colour of the RGB status LED for on or off is to be set in centrally.
  - The following settings are available to activate the status LEDs: **Always on/off**, as **Status display (on/up/down at 1)** or **Status display blinking at 1**.
- The backlighting can be set to **Always on**, **Always off** or as **Status display (on/up/down at 1)**.
- The full lighting on the device, the status LED and the backlighting can be fully switched off using an external command.
- The device has an internal temperature sensor and connecting terminals for an external temperature sensor. In addition, the room temperature can be measured, processed and sent to the bus.



## 2.4 Functional overview

The functions described in the following section enable the individual configuration of the device inputs or outputs.

**i** The symbols pictured are also pictured as a total overview in the appendix.

### 2.4.1 No function

The **No function** function means that no function is assigned to the button. The button is disabled.

### 2.4.2 Lighting

#### On / Off

With the **On/Off** function, the lighting is switched on or off when the relevant configured button is pressed.

#### Switching (push-button function)

The Switching

#### Toggle switch

The **Toggle switch** function switches on the lighting upon the first key-press and switches it off again upon the second.

#### Timer

The **Timer** function enables the actuator output to be switched on for an adjustable duration. The switching time can be interrupted before the delay time elapses. An adjustable switch-off warning signals the end of the delay time by inverting the output state for 1 s.

#### Priority toggle (On / Off )

The **Priority** function makes it possible to specify a defined state or to force a defined state of the function.

#### Scene

In the **Scene** function, several switching/dimming/blind outputs can be grouped together and switched on/off at the touch of a button. A maximum of 8 scenes can be created.

#### Automatic control deactivation toggle

This function can be used for time-controlled switching, interrupting and deactivating of ongoing operations, e.g. lighting.

### Communication commands Lighting function

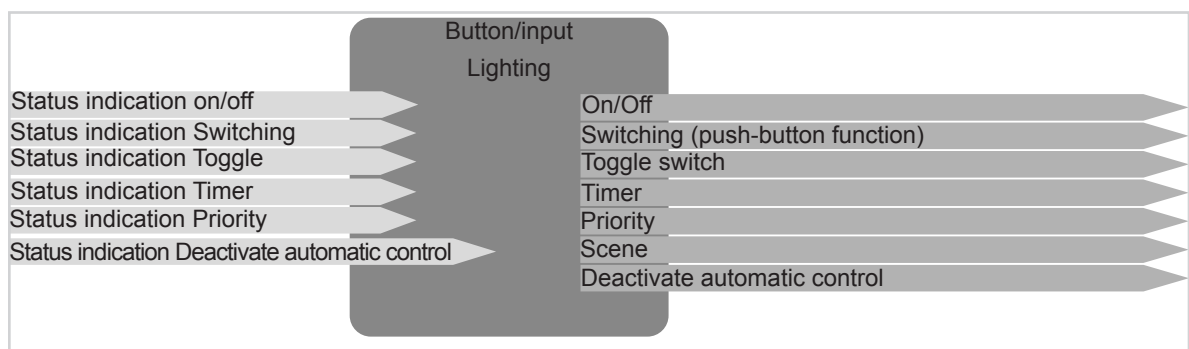

Figure 4: Input/output signals Lighting function

### 2.4.3 Dimming

#### Dimming up (on) / Dimming down (off)

With the **Dimming** function, the lighting or lighting circuit can be dimmed up or down (long press of the button) or switched on or off (short press of the button) by pressing the relevant configured button.

#### Dimming Up/Down

With the **Dimming up/down** function, the lighting can be dimmed up/down with the same button.

#### Dimming (Dimming value %)

The lighting is assigned a certain brightness value with the **Dimming (dimming value %)** function.

#### Scene

In the **Scene** function, several switching/dimming/blind outputs can be grouped together and switched on/off at the touch of a button. A maximum of 8 scenes can be created.

#### Automatic control deactivation toggle

This function can be used for time-controlled switching, interrupting and deactivating of ongoing operations, e.g. lighting.

### Communication commands Function dimming

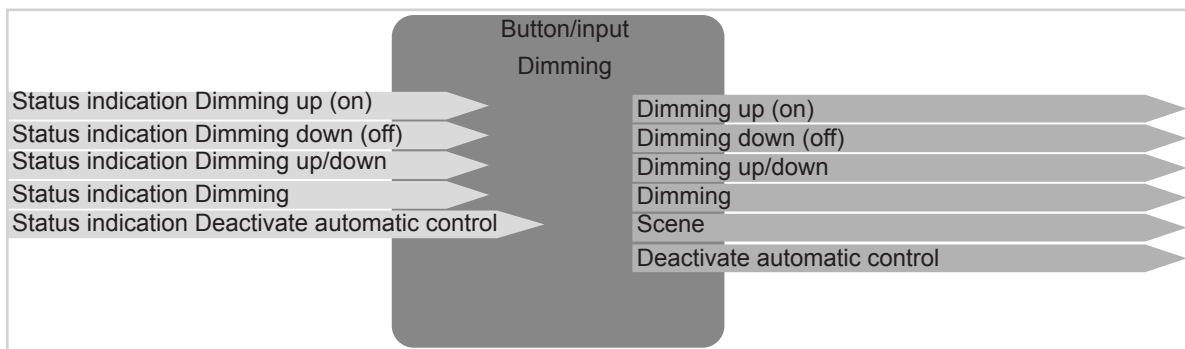

Figure 5: Input/output signals Dimming function

All functions from the **Lighting** function group can be linked with a dimming output. However, only the relevant **switching command** is executed in the switch output.

### 2.4.4 roller shutters

The shutter" function allows blinds, shutters, awnings or similar hangings to be opened and closed.

#### Roller shutters up / down - Blinds up / down

With these functions, it is possible to move a roller shutter/blind up/down or to open/close an awning, for example, by pressing the button.

#### Position roller shutter / roller shutter and slat / Slat angle

With these functions, it is possible to set the position of the roller shutter/blind or the angle of the slat by pressing the button.

#### Priority up toggle / down toggle

With these functions, it is possible to impose the up/down command in a roller shutter/blind actuator by pressing the button; in other words, the position that is currently set is interrupted and Priority mode is switched on. The Priority function makes it possible to specify a defined state or to force a defined state of the function., Example: window cleaner function.

#### Scene

In the **Scene** function, several switching/dimming/blind outputs can be grouped together and switched on/off at the touch of a button. A maximum of 8 scenes can be created.

#### Automatic control deactivation toggle

This function can be used for time-controlled switching, interrupting and deactivating of ongoing operations, e.g. blinds.

### Communication commands Function roller shutter

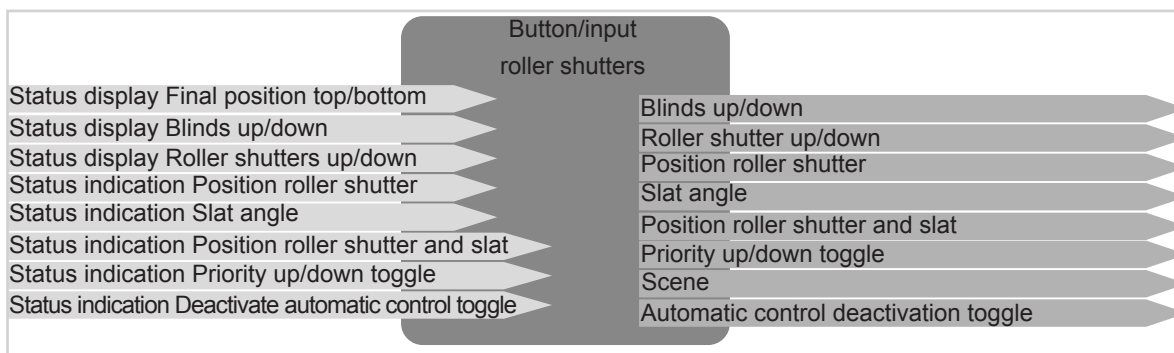





Figure 6: Input/output signals Roller shutter function

## 2.4.5 Heating/cooling

### Operating mode

- Comfort mode 
- Eco mode 
- Standby mode 
- Protection mode 

With one of these functions, it is possible to switch on/toggle the relevant operating mode – Comfort, Eco, Standby or Protection – by pressing the button.

### Setpoint shift $\pm x$

With this function, it is possible to increase/decrease the set temperature setpoint in the thermostat by pressing the button.

### Priority comfort toggle / Priority protection toggle

With one of these functions, it is possible to impose the Comfort/Protection mode in a thermostat by pressing the button; in other words, the Heating/cooling function which is currently running is interrupted and Priority mode is switched on. The Priority function makes it possible to specify a defined state or to force a defined state of the function.

### Heating/cooling toggle

With this function, it is possible to change between heating and cooling.

### Scene

In the **Scene** function, several switching/dimming/blind outputs can be grouped together and switched on/off at the touch of a button. A maximum of 8 scenes can be created.

### Automatic control deactivation toggle

This function can be used for time-controlled switching, interrupting and deactivating of ongoing operations, e.g. changing between heating/cooling.

### Communication commands Heating/cooling function

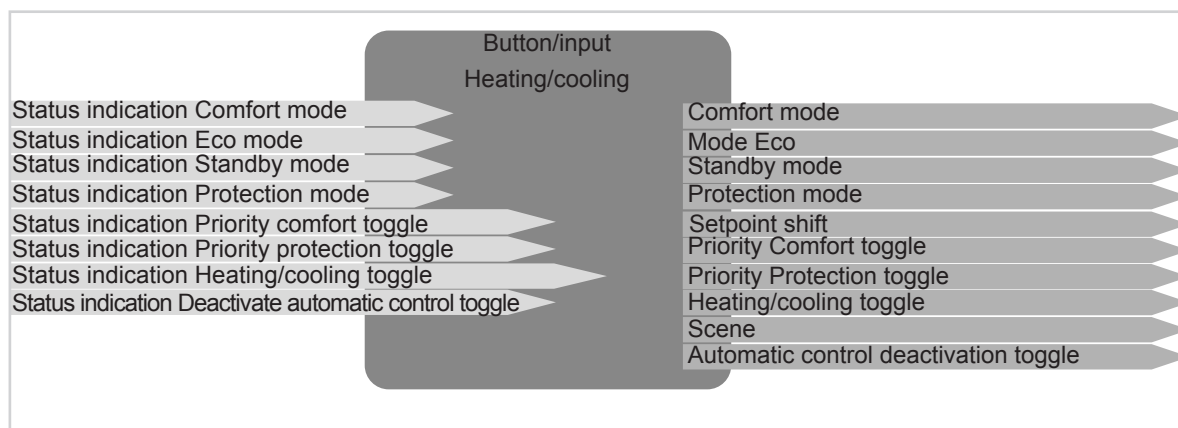

Figure 7: Input/output signals Heating/cooling function

### 3. Project preparation

The following sections describe the configuration of the parameters for 1 to 4-fold push-button devices. The function of the different devices only differ in the number of inputs. For this reason, only the first input pair/button pair will ever be described.

**i** The **configuration tool** is used for parameterisation and commissioning.

If all devices are integrated into the project, then you can start configuring the device.

**i** The set parameters are updated continuously during the configuration. The device signals that the parameters are being updated by making all of the status LEDs flash blue.

#### 3.1 Project editing

To ensure that the commissioning process with the **configuration tool** is successful, the following requirements must be met:

- ✓ A network connection to the **configuration tool** has been established.
- ✓ All of the devices used (wired and wireless) are connected to the **configuration tool**.
- ✓ Start the **configuration tool** software (browser version or tablet app).
- ✓ Create the project and enter the project-specific data (project name, address, customer data).
- ✓ Click on search to scan devices.

The **configuration tool** has scanned the device and started with the parameterisation.

### 3.2 Device choice

First of all, the corresponding device must be selected in the device listing to make it possible to start with the configuration.

- Click ► on the **devices xgang push-button** in the device overview.

The following view opens (Figure 8).

All of the device inputs and device outputs are listed on the right-hand side (Figure 8, 1).

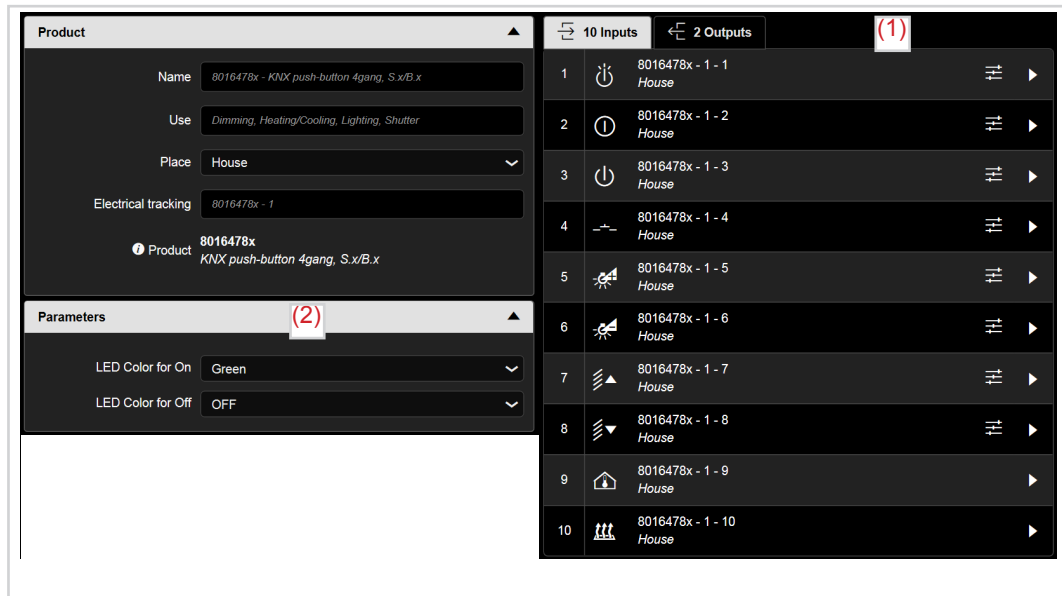

Figure 8: Device information

#### 3.2.1 Menu field - parameters

The settings for the colour of the status LED when the connecting load is on and off must be made under Parameters (Figure 8, 2). These settings are made for the complete device.

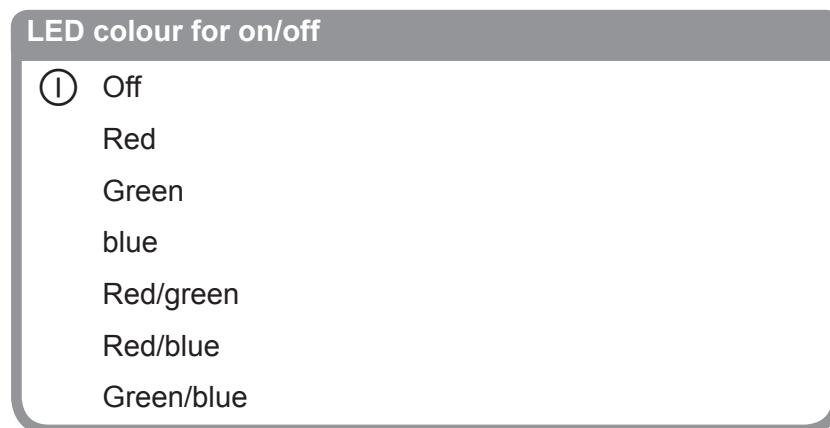

Figure 9: Colour choice status LED

Parameters	Description	Value
LED colour for <b>on</b>	This parameter allows the status LED colour when <b>ON</b> to be set for the complete device.	OFF Red <b>Green *</b> Blue Red / green Red / blue Green/blue
LED colour for <b>off</b>	This parameter allows the status LED colour when <b>OFF</b> to be set for the complete device.	<b>OFF</b> Red Green * Blue Red / green Red / blue Green/blue

Table 1: Setting Colour of status LED

\* Default value

### 3.3 Overview inputs/outputs

The number of device inputs and outputs is determined by the device type used.  
The next figure shows the inputs for the push-button on the left-hand side and the outputs on the right-hand side.















10 inputs		2 outputs	
	8016478x - 1 -1 House		8016478x - 1 -1 House - lighting
	8016478x - 1 -2 House		8016478x - 1 -2 House - lighting
	8016478x - 1 -3 House		
	8016478x - 1 -4 House		
	8016478x - 1 -5 House		
	8016478x - 1 -6 House		
	8016478x - 1 -7 House		
	8016478x - 1 -8 House		
	8016478x - 1 -9 House		
	8016478x - 1 -10 House		

Figure 10: Overview inputs/outputs

The device described and pictured here features a total of 10 inputs and two outputs. The inputs are split into the actual inputs/buttons 1-8 and two inputs for configuring the temperature control.

- Inputs/buttons 1 - 8  
The "Lighting – Dimming – Roller shutters – Heating/cooling" functions can be assigned to the inputs/buttons 1 - 8.
- Inputs/buttons 9 - 10  
These inputs/buttons are assigned the "Room temperature" and "Floor temperature" functions permanently.

Outputs refer to functions which are triggered by pressing another button or by timer functions, e.g. function of backlighting or switching off all status LEDs on the device if necessary.

- Ausgang 1: Backlighting  \*\*  
In the parameters for output 1, the settings and function of the backlighting must be made.
- Output 2: Switch off status LEDs   
Under output 2, the status LEDs for the entire device can be switched off if necessary, e.g. at night (1-command) and switched back on again in the day with a 0-command.

\*\* FPL = Front Product Labeling



### 3.4 Parameterisation of Status LED / backlighting

#### 3.4.1 Function status LED

In this section, the functions of the status LEDs for the inputs/buttons are described. Each rocker is fitted with one RGB status LED that are connected internally to the operating function depending on the function of the buttons.

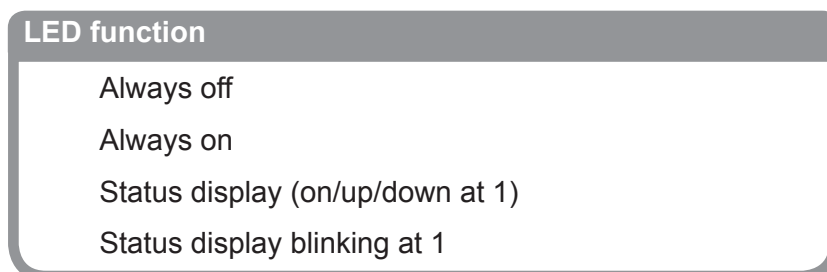

Figure 11: Function selection status LED

Parameters	Description
Always off	The status LED of the selected button is always switched off.
Always on	The status LED of the selected button is always switched on.
Status display (on/up/down at 1) *	The status LED of the selected button is switched on with an on, up or down command.
Status display blinking at 1	The status LED of the selected button is switched on flashing with an on, up or down command. The flashing frequency is 2 Hz.

Table 2: Function of the status LED

\* If an output is controlled by several inputs, then the function of the status LED is set to status display (on/up/down at 1) automatically for all devices used.

#### 3.4.2 Backlighting FPL

To be able to set the function of the backlighting FPL, all of the outputs of the device must be selected to start with (Figure 12).

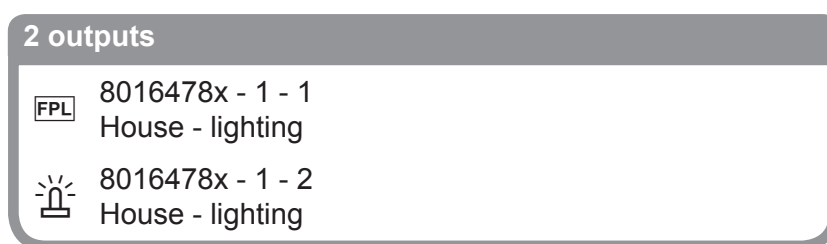



Figure 12: Select LED

Clicking on the symbol  opens a parameter window to set the function of the backlighting (Figure 13). The LED is located with the push-buttons for the design lines S.1; B.x; K.x; Q.x; R.x on the bottom edge of the device (Figure 14, 1).

**Function of the backlighting**

- Always off
- Always on
- Status display (on/up/down at 1)

Figure 13: Function selection Backlighting

Parameters	Description
Always off	The backlighting of the device is always switched off.
Always on	The backlighting of the device is always switched on.
Status display (on/up/down at 1)	The backlighting of the device is always switched on with an on, up or down command.

Table 3: Function of the backlighting

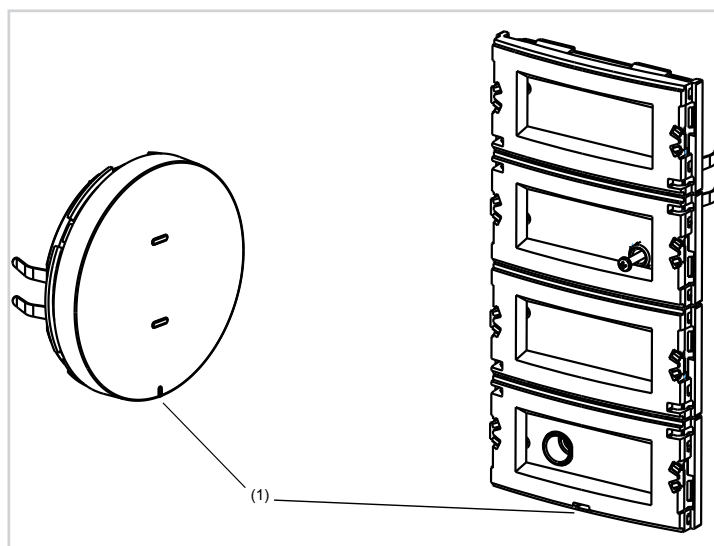

Figure 14: LED backlighting push-button R.x (left) – S.1 (right)

### 3.4.3 Switch off device LEDs

With this function, it is possible to switch off all RGB status LEDs and the backlighting of the device with a command from a timer, another push-button or a brightness sensor, e.g. at night.

Inputs			Outputs	
	80142180 - 1 -1 <i>House</i>			8016478x - 1 -2 <i>House - lighting</i>
	80142180 - 1 -2 <i>House</i>			

Figure 15: Switching off the status LED / backlighting

## 4. Configuration independent push-button

This chapter describes the configuration of the independent push-button. Only the first pair of independent push-buttons is described. Additional independent push-buttons must be configured accordingly. The functions of the button/input are divided into the following function groups.

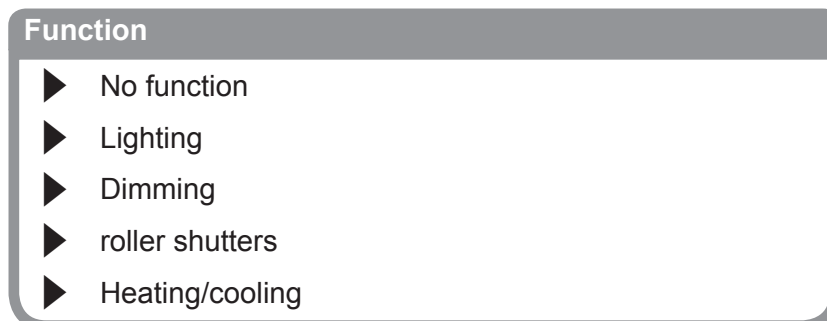



Figure 16: Function selection of the independent push-button

The **No Function** function  is preset at the beginning of the parameterisation. This means that the relevant button/input is not active.

The **Lighting**, **Dimming**, **Roller shutter** and **Heating/cooling** functions have different sub-functions, which are described in the following sections.

Parameters	Description	Value
No function	The input has no function (inactive).	
Lighting	This parameter sets the function of the individual button under <b>Lighting</b> .	On Off Switching (push-button function) Toggle Timer Priority toggle Scene Deactivate automatic control toggle
Dimming	This parameter sets the function of the individual button under <b>Dimming</b> .	Dimming up (on) Dimming down (off) Dimming up/down Dimming Scene Automatic control deactivation toggle
roller shutters	This parameter sets the function of the individual button under <b>Roller shutter</b> .	Blind up Blind down Roller shutter position Slat angle Roller shutter and slat position Roller shutter up Roller shutter down Priority up toggle Priority down toggle Scene Automatic control deactivation toggle
Heating/cooling	This parameter sets the function of the individual button under <b>Heating/cooling</b> .	Comfort mode Eco mode Standby mode Protection mode Setpoint offset Priority comfort toggle Priority protection toggle Heating/cooling toggle Scene Automatic control deactivation toggle

Table 4: Function of the button

## 4.1 Functions Lighting

The "Lighting" function is used to switch the lighting or socket circuits on/off with a switch actuator.

**i** All of the combination possibilities between inputs – outputs/inputs are listed at the end of the chapter.

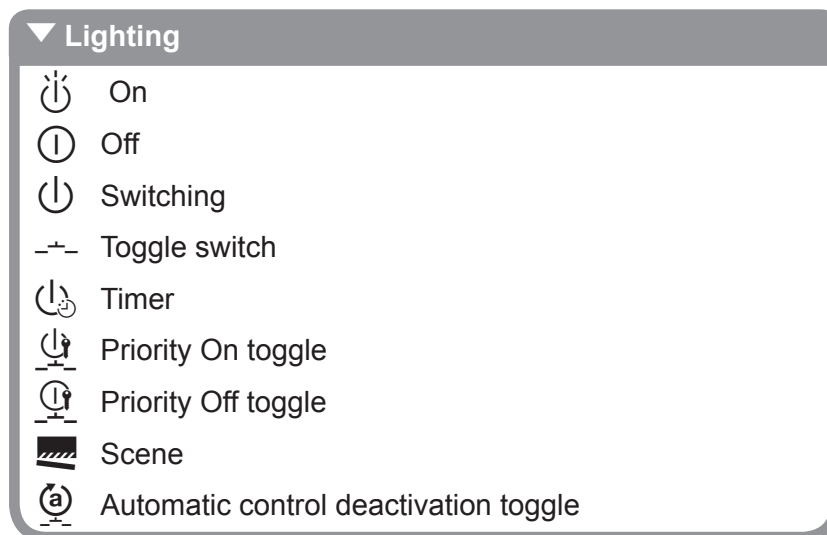

Figure 17: Functional overview lighting

### 4.1.1 Functions On / Off

The **On/Off** functions are used to control the lighting and socket circuits. The two adjacent buttons/ inputs should be parameterised with the functions Lighting **On** and Lighting **Off** so that the lighting can be switched on and off by a key (Figure 18).

Inputs			Outputs	
	8016478x - 1 -3 House			TXA610 - 1 -3 House - lighting
	8016478x - 1 -4 House			

Figure 18: Linking function **On - Off**

#### 4.1.2 ON/OFF functions (buttons)

Pressing the button switches on the switch actuator channel and releasing the button switches it off again (push-button function). The function can be used to switch on an installation contactor/ self-retaining relay, for example (conventionally wired stairway timer or bell push-button).

Inputs			Outputs	
	8016478x - 1 -2 <i>House</i>			TXA610 - 1 -2 <i>House - lighting</i>

Figure 19: Linking Function **switching**

#### 4.1.3 Toggle switch function

The "Toggle switch" function means changing over. When the "Toggle switch" function is active, pressing the same independent push-button triggers an alternate switching command.

Inputs			Outputs	
	8016478x - 1 -1 <i>House</i>			TXA610 - 1 -1 <i>House - lighting</i>

Figure 20: Linking **Toggle switch** function

#### 4.1.4 Timer function

In the Timer function, when a short key-press occurs, the corresponding switch output is switched for the time set in the switch actuator. When a long key-press occurs, the ongoing timer operation is interrupted and the switch output is switched off.

Inputs			Outputs	
	8016478x - 1 -2 <i>House</i>			TXA610 - 1 -1 <i>House - lighting</i>

Figure 21: Linking **Timer** function

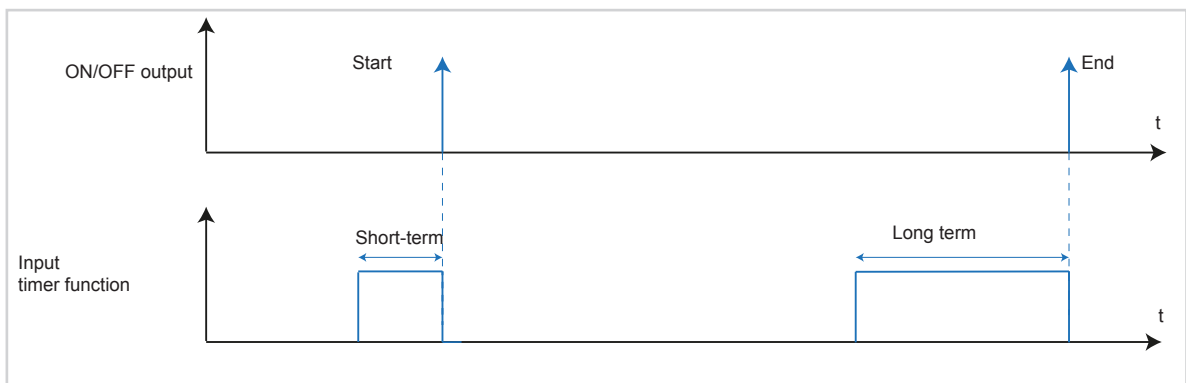

Figure 22: Signal-time diagram for timer

### 4.1.5 Functions priority toggle On / Off

This function allows a switch output to be forced to a switch position regardless of the switching signal (higher priority). As a result, the Priority can be switched on/off with the same button (toggle).



Inputs			Outputs	
	8016478x - 1 -2 <i>House</i>			TXA610 - 1 -1 <i>House - lighting</i>

Figure 23: Linking **Priority on toggle** function



Inputs			Outputs	
	8016478x - 1 -3 <i>House</i>			TXA610 - 1 -1 <i>House - lighting</i>

Figure 24: Linking **Priority off toggle** function

When "Priority" is active, incoming switch telegrams are still evaluated and the parameters set in the switch output are executed when "Priority" is not active.

A "Priority" function activated before a bus voltage failure is always deactivated after a bus voltage recovery. The effect of the "Priority" function depends on the actuator channel connected (lighting, shutter/blind, heating).

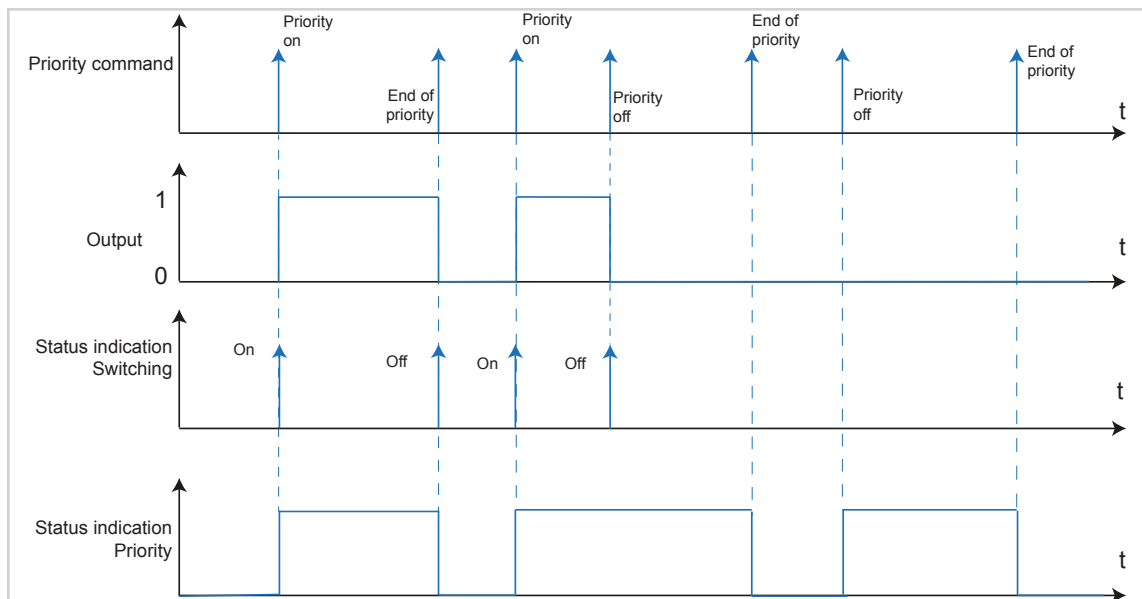

Figure 25: Signal-time diagram for Priority

#### Example: Locking motion detector

The **Locking motion detector** function is an application which prevents the motion detector from switching the lighting on/off constantly during an event, for example. As a result, the motion detector operation is disabled from a central point. The motion detector function is also enabled from a central point.

#### 4.1.6 Scene function

The **Scene** function can be used as a scene extension and can be used to call up or save configured light scenes that are stored in other KNX devices. The device can call up and save a maximum of 8 scenes. Through a short key-press, the device transmits a value between 0 and 7 (where value 0 corresponds to scene 1 and value 7 corresponds to scene 8) to the bus. The scene is called up when the button is released.



Inputs			Outputs	
	8016478x - 1-2 <i>House</i>			TXA610 - 1-1 <i>House - lighting</i>

Figure 26: Linking **Scene** function

After selecting the Scene function, an additional menu field opens to determine the scene number. A scene between 1 - 8 can be entered here (Figure 27).



Figure 27: Entering the scene number

The related scene parameter values can be changed with the corresponding operating sections and stored with a long button press.

#### Example: Scene TV

In the Scene TV example, the typical scene values are changed and then the scene is saved again.

- Switch on scene using a short press of the button (Figure 28, A).

Scene is activated e.g., lighting dimmed to 30%, blind closed to 85%.

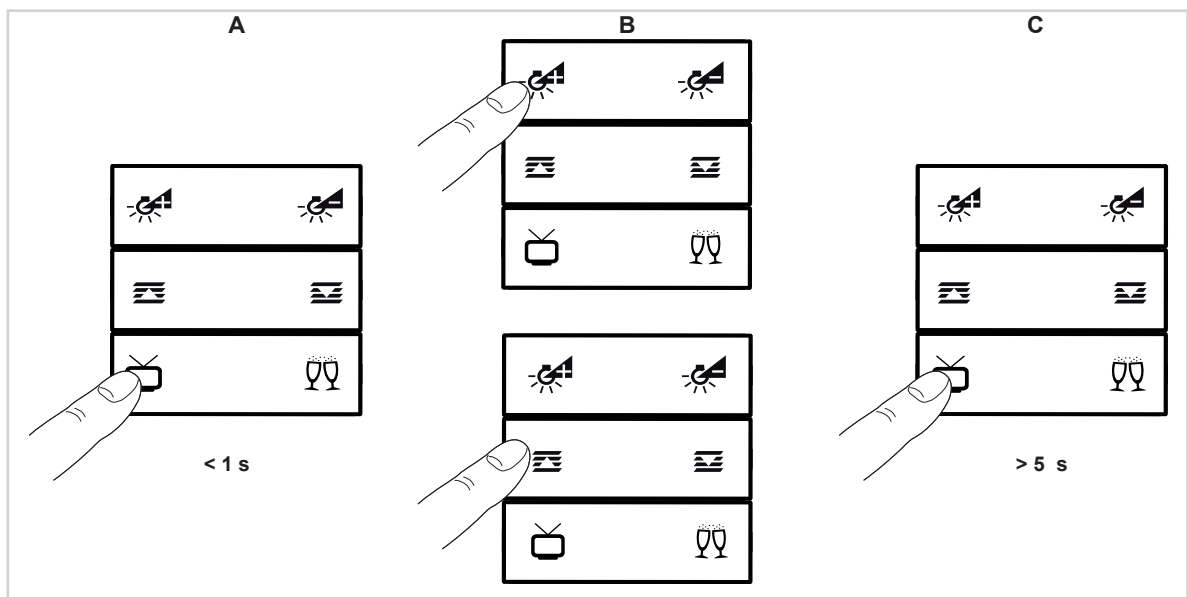





Figure 28: Scene call-up

Set new scene parameters on the push-button (Figure 28, B).

- Change lighting intensity, dim brighter or darker.

- Change blind position
  - Hold the button for Scene TV  for longer than 5 s (Figure 28, C).  
New scene parameters have been saved. Pressing the  button again activates the new scene settings.
- i** The Save scene by a long key-press function is switched on by default.









































































### 4.1.7 Automatic control deactivation toggle

The precise description of the **Deactivate automatic control toggle**  function can be found in Chapter „4.3.9 Automatic control deactivation toggle “.



### 4.1.8 Overview of all possible linking combinations

The following overview shows all linking combination possibilities for the **Lighting** function. It is worth noting that inputs can also be linked with inputs (depending on the function selection).

		Linking		
Input 			Output 	
	8016478x - 1 -1 House			Orientation/labelling field illumination
				ON/OFF output
				Dimming output
				Logic function
				Fan-Coil output
	8016478x - 1 -1 House			Orientation/labelling field illumination
				ON/OFF output
				Dimming output
				Logic function
				Fan-Coil output
	8016478x - 1 -1 House			Orientation/labelling field illumination
				ON/OFF output
				Dimming output
				Logic function
				Fan-Coil output
	8016478x - 1 -1 House			Orientation/labelling field illumination
				ON/OFF output
				Dimming output
				Logic function
				Fan-Coil output
	8016478x - 1 -1 House			ON/OFF output
				Dimming output
				Fan-Coil output
	8016478x - 1 -1 House			ON/OFF output
				Dimming output
				Fan-Coil output
	8016478x - 1 -1 House			ON/OFF output
				Dimming output
				Fan-Coil output
	8016478x - 1 -1 House			ON/OFF output
				Dimming output

































Linking				
Input 			Output 	
	8016478x - 1 -1 House			ON/OFF output
				Dimming output
	8016478x - 1 -1 House			ON/OFF output
				Dimming output
	8016478x - 1 -1 House			ON/OFF output
				Dimming output
	8016478x - 1 -1 House			ON/OFF output
				Dimming output
	8016478x - 1 -1 House			ON/OFF output
				Dimming output
	8016478x - 1 -1 House			ON/OFF output
				Dimming output

Figure 29: Combination possibilities **Lighting** input – output

## 4.2 Dimming functions

The lighting can be switched on/off (short press of button) and dimmed brighter/darker (long press of button) with the **Dimming** function.

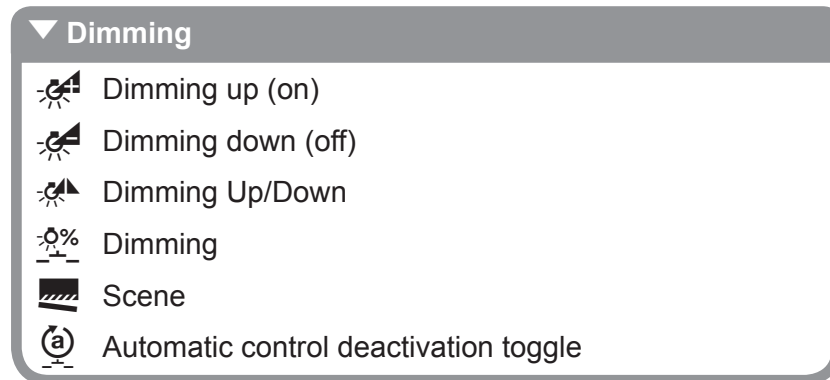

Figure 30: Functional overview **Dimming**

**i** All functions from the **Lighting** function group can be linked with a dimming output. Only the relevant **switching commands** is executed.

### 4.2.1 Functions Dimming Up (ON) / Down (Off)

With the Dimming up (on)/down (off) functions, lighting circuits/lights are switched on/off with a short press of the button and dimmed up or down with a long press of the button. This means that two buttons are needed dimming. One button for Dimming up (on) and the second button for Dimming down (off). (Figure 31).

Inputs			Outputs	
	8016478x - 1 -1 <i>House</i>			TXA661A - 1 -1 <i>House - lighting</i>
	8016478x - 1 -2 <i>House</i>			

Figure 31: Linking **Dimming up (on)/down (off)** function

### 4.2.2 Functions Dimming Up/Down

With this function, the lighting can be switched on/off with a short press of the button and dimmed up/down with a long press of the same button (toggle).

Inputs			Outputs	
	8016478x - 1 -1 <i>House</i>			TXA661A - 1 -1 <i>House - lighting</i>

Figure 32: Linking **Dimming up/down** function

### 4.2.3 Function Dimming

When the **Dimming – dimming value** function is selected, the lighting is switched on at a fixed dimming value set previously. The dimming value is entered in an additional menu field (Figure 34) as a whole number. The range for the dimming value is between 0 % and 100 %. The **Dimming – dimming value** function assigns a specific brightness value to the lamp via the connected actuator.



Inputs			Outputs	
	8016478x - 1 -1 <i>House</i>			TXA661A - 1 -1 <i>House - lighting</i>

Figure 33: Linking **Dimming – dimming value** function

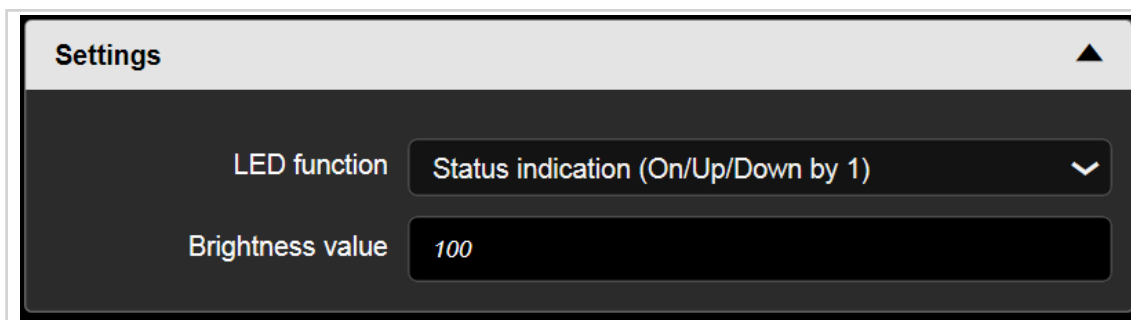



Figure 34: Set dimming value

### 4.2.4 Scene function

The precise description of the **Scene** function can be found in Chapter „4.1.6 Scene function “.

### 4.2.5 Automatic control deactivation toggle

The precise description of the **Automatik control deactivation**  function can be found in chapter „4.3.9 Automatic control deactivation toggle “.

### 4.2.6 Overview of all possible linking combinations

The following overview shows all linking combination possibilities for the **Dimming** function. It is worth noting that inputs can also be linked with inputs (depending on the function selection).













































		Linking		
Input 			Output 	
	8016478x - 1 -1 House			ON/OFF output
				Dimming output
	8016478x - 1 -1 House			ON/OFF output
				Dimming output
	8016478x - 1 -1 House			ON/OFF output
				Dimming output
	8016478x - 1 -1 House			ON/OFF output
				Dimming output
	8016478x - 1 -1 House			ON/OFF output
				Dimming output
	8016478x - 1 -1 House			Dimming output
	8016478x - 1 -1 House			ON/OFF output
				Dimming output
	8016478x - 1 -1 House			Dimming output
	8016478x - 1 -1 House			Dimming output
	8016478x - 1 -1 House			Dimming output

Figure 35: Combination possibilities **Dimming** input – output

## 4.3 Roller shutter function

The **Roller shutter** function for the buttons/inputs is configured in the following parameter windows.

This function is used for activating roller shutters, blinds, awnings and other hangings. With the Roller shutter and Blind functions, a distinction is made between a long and short button press.

- Short button press: the device transmits a slat step or stop command to the bus.
- Long button press: the device sends a move command (up/down) to the bus.

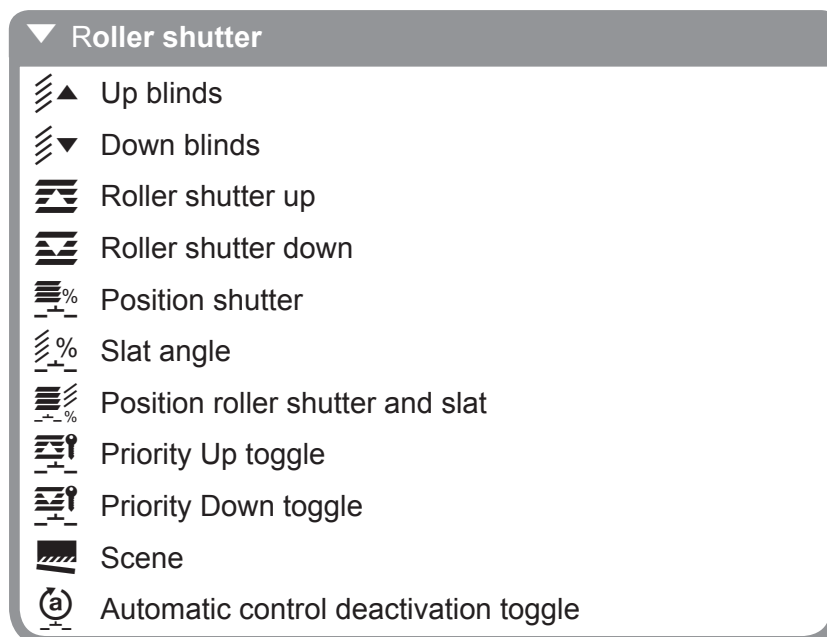

Figure 36: Functional overview **Roller shutter**

### 4.3.1 Basis roller shutter/blind control

For roller shutter/blind drives with limit switches, the position of the roller shutter/blind can be brought into the correct position by specifying a percentage value. The following settings are to be respected:

For blind drives, a distinction is also made between slats arranged horizontally and vertically.

#### Slat adjustment for slats arranged horizontally

The top final position of the roller shutter/blinds is set using the value 0 % and returned as a status value.

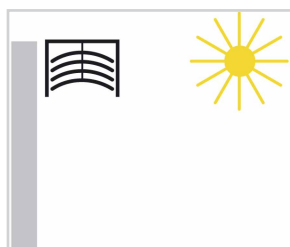

Function position in %

- Sun protection completely open
- Top final position reached: 0 %

Figure 37: Blind position top final position 0 %

The bottom final position of the roller shutter/blinds is set using the value 100 % and returned as a status value.

If a blind drive is moved from the top final position into the lower final position, then the slats will initially tilt into a nearly vertical position and the blind will move with closed slats until it reaches the bottom final position.

If a blind is in the bottom final position and the slats are fully closed, then this slat position is identified as vertical and 100 %. However, the fully closed slats cannot be exactly vertical ( $\alpha = 180^\circ$ ); instead, they are at a slight angle from the vertical.

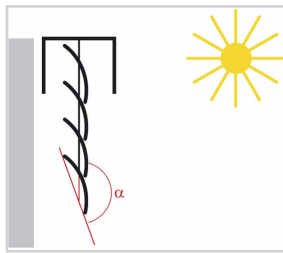

Function position in %

- Sun protection completely closed
- Top final position reached: 100 %

Figure 38: Blind position bottom final position

If the blind is set into motion from the vertical position (bottom end position, 100 % fully closed), the slats move into the horizontal position ( $\alpha = 90^\circ$ ). With the Slat adjustment function, it is possible determine the number of steps so that the slats can be adjusted almost infinitely.

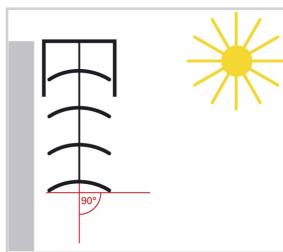

Slat angle in %

- Slat position horizontal ( $\alpha = 90^\circ$ )

Figure 39: Adjust slat angle

With blinds, the position of the slats can be adjusted beyond the horizontal position until they have reached the maximum point to which they can be adjusted and the blind starts moving towards the top final position. The slat angle can therefore adopt a value between 0 and  $90^\circ$ .

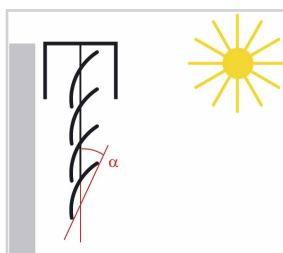

Slat angle in %

- Slat position at the start of the movement towards the top final position

Figure 40: Slat angle at the start of the movement towards the top final position

### Slat adjustment for slats arranged vertically

When there is shade or screen with slats arranged vertically, the shade behaves like slats arranged horizontally. As a result, when the slats are fully open, the value 0 % is transmitted and returned as a status value. The slats therefore form an angle of  $\alpha = 90^\circ$  the fully open shade to the fully closed shade.

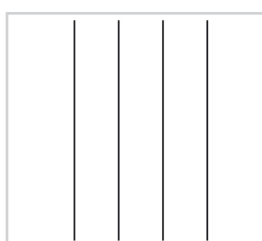

Slat angle in %

- Fully open slats arranged vertically  $\alpha = 90^\circ$

Figure 41: Slat angle for slats arranged vertically  $\alpha = 90^\circ$

Fully closed slats are operated with a value of 100 %, which is also returned as a status. The angle which the slats form with the direction of travel is approximately  $0^\circ$ .

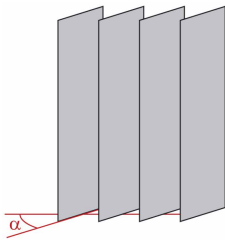

Slat angle in %

- Fully closed slats arranged vertically  $\alpha \approx 0^\circ$

Figure 42: Slat angle for slats arranged vertically  $\alpha \approx 0^\circ$

If the shade is open, the slats turn into a position at an angle a little less than  $180^\circ$ .

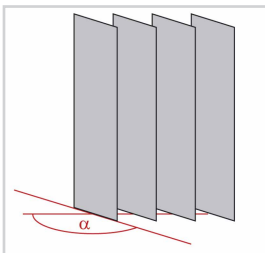

Slat angle in %

- Slats arranged vertically when opening  $\alpha \approx 180^\circ$

Figure 43: Slat angle when opening  $\alpha \approx 180^\circ$



### 4.3.2 Functions blinds up / blinds down

If the button/input is assigned the Blind up/down function, the blinds can therefore be moved up and down. A motion command is transmitted to the actuator if the button is pressed for a long time and a stop command is transmitted if the button is pressed for a short time.

Inputs			Outputs	
	8016478x - 1 -1 <i>House</i>			TXA610 - 1 -1 <i>House - roller shutter</i>
	8016478x - 1 -1 <i>House</i>			

Figure 44: Linking **Blind up/down** function

Further information, e.g. operating mode, running time to top/bottom final position, can be found in the application description for the respective roller shutter/blind output.

### 4.3.3 Function roller shutter position

A short press on the button configured with the **Roller shutter position** function switches the roller shutter output on until it reaches the set position between 0 and 100 % (Figure 46).

- 0 %: top final position reached: 0 %, roller shutter/blind is open
- 100 %: bottom final position reached: 0 %, roller shutter/blind is closed

Inputs			Outputs	
	8016478x - 1 -2 <i>House</i>			TXA610 - 1 -1 <i>House - roller shutter</i>

Figure 45: Linking **Roller shutter position** function

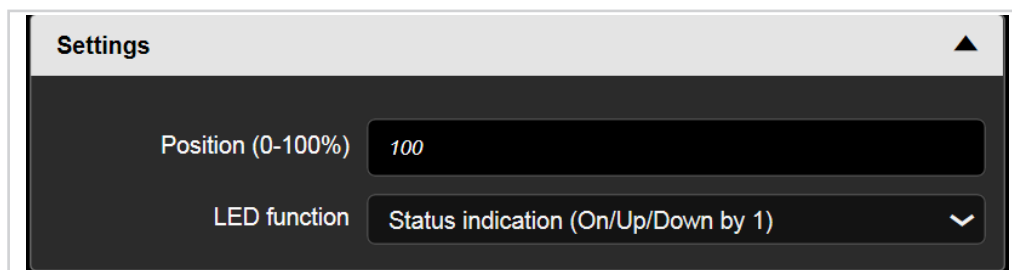

Figure 46: Entering the roller shutter position between 0 and 100 %

#### 4.3.4 Function slat angle

A short press on the button configured with the **Slat angle** function switches on the blind output until it reaches the set slat angle 0 - 100 % (Figure 48).

Inputs			Outputs	
	8016478x - 1 -2 <i>House</i>			TXA610 - 1 -1 <i>House - roller shutter</i>

Figure 47: Linking **Slat angle** function

**Settings** ▲

LED function Status indication (On/Up/Down by 1) ▼

Slat angle (0-100%) 100

Figure 48: Entering the slat angle 0 - 100 %

#### 4.3.5 Functions Roller shutter and slat position

A short press on the button configured with the **Roller shutter and slat position** function switches the roller shutter/blind output on until it reaches the set slat angle between 0 and 100 % and the position between 0 and 100 % (Figure 50).

Inputs			Outputs	
	8016478x - 1 -2 <i>House</i>			TXA610 - 1 -1 <i>House - roller shutter</i>

Figure 49: Linking **Roller shutter and slat position** function

**Settings** ▲

Position (0-100%) 100

Slat angle (0-100%) 100

LED function Status indication (On/Up/Down by 1) ▼

Figure 50: Entering the position/slat angle 0 - 100 %

### 4.3.6 Functions roller shutter up / roller shutter down

If the button/input is assigned the **Roller shutter up/down** function, the roller shutters can therefore be moved up and down. A motion command is transmitted to the output if the button is pressed for a long time and a stop command is transmitted if the button is pressed for a short time.

Inputs			Outputs	
	8016478x - 1 -1 <i>House</i>			TXA610 - 1 -1 <i>House - roller shutter</i>
	8016478x - 1 -1 <i>House</i>			

Figure 51: Linking **Roller shutter up/down** function

**i** Further information, e.g. operating mode, running time to top/bottom final position, can be found in the settings for the respective roller shutter/blind output.

### 4.3.7 Functions Priority up toggle / down toggle

The **Priority** function allows a roller shutter/blind output to be forced to a switch position by a telegram regardless of a switching command (higher priority). As a result, the Priority can be switched on/off with the same button (toggle).

Inputs			Outputs	
	8016478x - 1 -2 <i>House</i>			TXA610 - 1 -1 <i>House - roller shutter</i>

Figure 52: Linking **Priority up toggle** function

Inputs			Outputs	
	8016478x - 1 -3 <i>House</i>			TXA610 - 1 -1 <i>House - roller shutter</i>

Figure 53: Linking **Priority down toggle** function

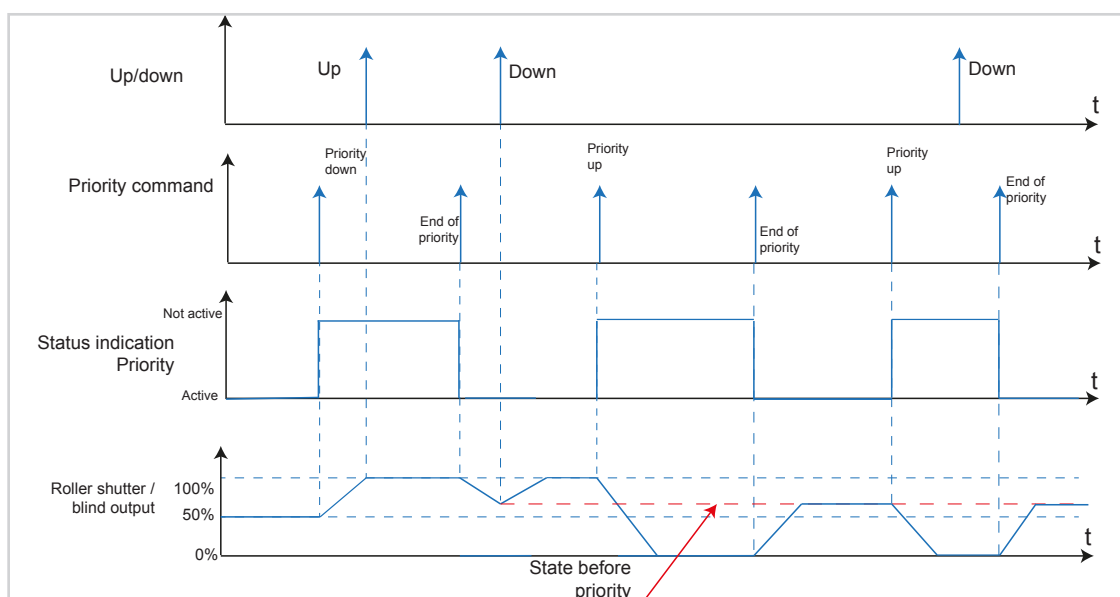

Figure 54: Signal-time diagram for **Priority roller shutter/blind**

**The value of the telegram is defined according to the following syntax:**

When "Priority" is active, incoming switch telegrams are still evaluated internally; when "Priority" is no longer active, the current switch condition is set.

A "Priority" function activated before a bus voltage failure is always deactivated after a bus voltage recovery. The effect of the "Priority" function depends on the actuator channel connected (lighting, shutter/blind, heating).

**Example: "Window cleaner" function**

The window cleaner function is an application that prevents a manual operation of the blind/roller shutter from being executed during the window cleaning. As a result, the blind/roller shutter operation is disabled from a central point. Blinds that have already been lowered are moved to the upper stop position. The manual blind/roller shutter function is also enabled from a central point.

**4.3.8 Scene function**

The precise description of the **Scene** function can be found in Chapter „4.1.6 Scene function“.

**4.3.9 Automatic control deactivation toggle**

With this function, it is possible to deactivate and activate the automatic functions in the actuators which are already running (Toggle mode).

Inputs			Outputs	
	8016478x - 1 -2 <i>House</i>			TXA610 - 1 -1 <i>House - lighting</i>

Figure 55: Linking **Automatic control deactivation toggle** function

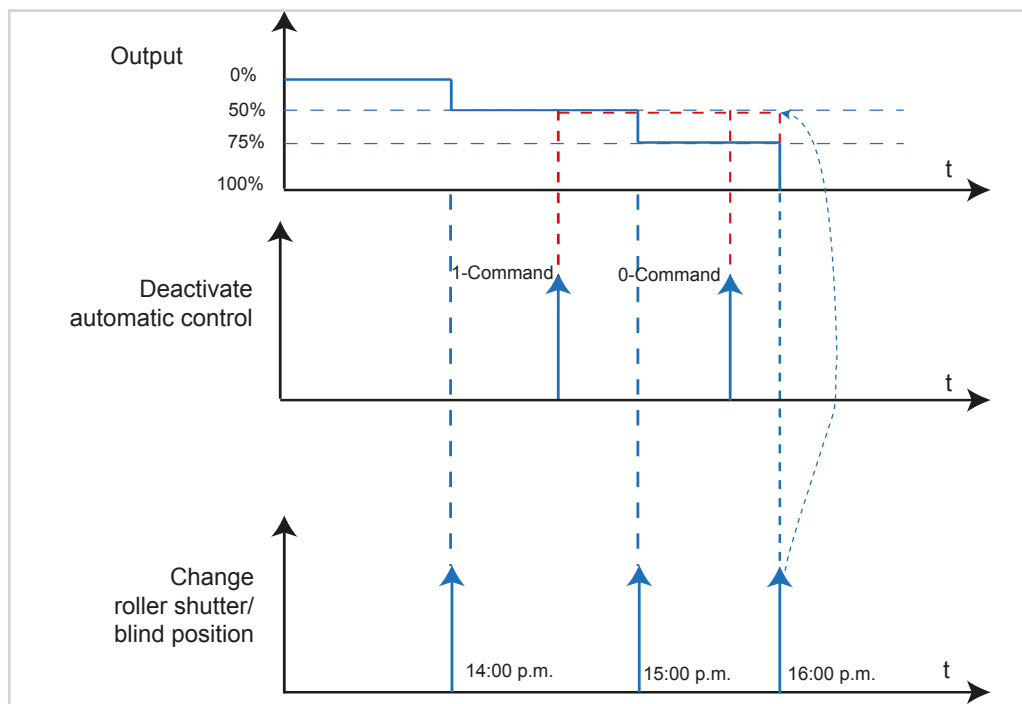





















































































Figure 56: Signal-time diagram for Automatic control deactivation

### Example: Shading control using position of sun

The shading control should move the blind up and down depending on the position of the sun. In the example (Figure 56), the blind is moved to different positions at 2 p.m., 3 p.m. and 4 p.m. Between 2 p.m. and 3 p.m. (1), the button with the **Deactivate automatic control** function is pressed. As a result, the blind position for 3 p.m. is not carried out, but remains in the 2 p.m. position. Between 3 p.m. and 4 p.m. (2), the button with the **Deactivate automatic control** function is pressed again (toggle operation). The Deactivate automatic control function is now switched off and the blind moves into the corresponding position at 4 p.m.

### 4.3.10 Overview of all possible linking combinations

The following overview shows all linking combination possibilities for the **Roller shutter** function.

Linking				
Input 			Output 	
	8016478x - 1 -1 House			Output roller shutter/blind
	8016478x - 1 -1 House			Output roller shutter/blind
	8016478x - 1 -1 House			Output roller shutter/blind
	8016478x - 1 -1 House			Output roller shutter/blind
	8016478x - 1 -1 House			Output roller shutter/blind
	8016478x - 1 -1 House			Output roller shutter/blind
	8016478x - 1 -1 House			Output roller shutter/blind
	8016478x - 1 -1 House			Output roller shutter/blind
	8016478x - 1 -1 House			Output roller shutter/blind
	8016478x - 1 -1 House			Output roller shutter/blind
	8016478x - 1 -1 House			Output roller shutter/blind
	8016478x - 1 -1 House			Output roller shutter/blind
	8016478x - 1 -1 House			Output roller shutter/blind
	8016478x - 1 -1 House			Output roller shutter/blind
	8016478x - 1 -1 House			Output roller shutter/blind
	8016478x - 1 -1 House			Output roller shutter/blind
	8016478x - 1 -1 House			Output roller shutter/blind
	8016478x - 1 -1 House			Output roller shutter/blind
	8016478x - 1 -1 House			Output roller shutter/blind
	8016478x - 1 -1 House			Output roller shutter/blind
	8016478x - 1 -1 House			Output roller shutter/blind
	8016478x - 1 -1 House			Output roller shutter/blind
	8016478x - 1 -1 House			Output roller shutter/blind
	8016478x - 1 -1 House			Output roller shutter/blind
	8016478x - 1 -1 House			Output roller shutter/blind
	TXE530 - 1 -1 House			Output roller shutter/blind
	TXE530 - 1 -1 House			Output roller shutter/blind



















































Linking				
Input 			Output 	
	8016478x - 1 -1 House			Output blind
	8016478x - 1 -1 House			Output blind
	8016478x - 1 -1 House			Output roller shutter/blind
	8016478x - 1 -1 House			Output blind
	8016478x - 1 -1 House			Output roller shutter/blind
	8016478x - 1 -1 House			Output roller shutter/blind
	8016478x - 1 -1 House			Output blind
	8016478x - 1 -1 House			Output roller shutter/blind
	8016478x - 1 -1 House			Output roller shutter/blind
	8016478x - 1 -1 House			Output blind
	8016478x - 1 -1 House			Output roller shutter/blind
	8016478x - 1 -1 House			Output roller shutter/blind
	8016478x - 1 -1 House			Output blind
	8016478x - 1 -1 House			Output roller shutter/blind
	8016478x - 1 -1 House			Output blind
	8016478x - 1 -1 House			Output roller shutter/blind

Figure 57: Combination possibilities **Roller shutter** input – output

## 4.4 Functions Heating/cooling

The **Heating/cooling** function allows an external KNX room thermostat to be activated using the push-button operation buttons.

This allows the user to change/adjust basic controller functions (such as operating mode change-over, setpoint selection, heating/cooling change-over) from different places in the room.

**i** The room thermostat extension unit, however, is not involved in actually controlling the temperature.

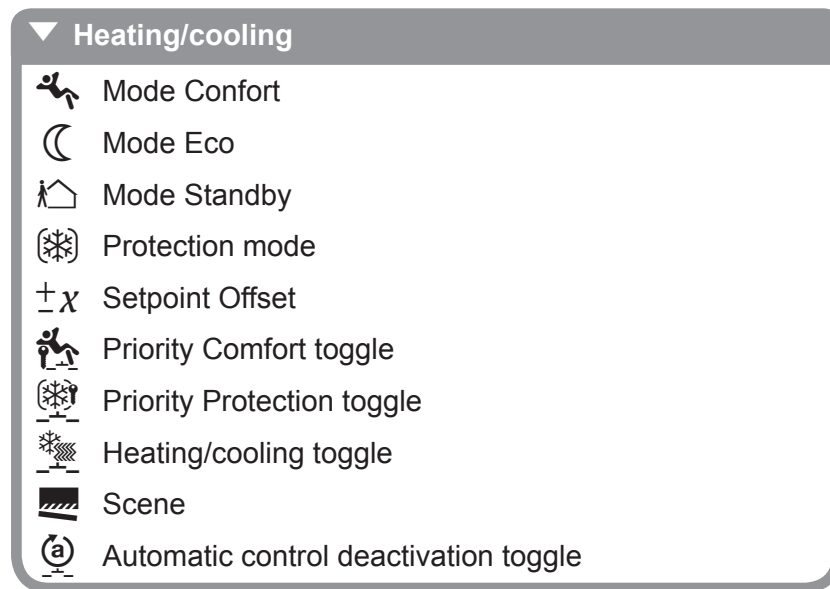

Figure 58: Functional overview **Heating/cooling**

With the Comfort, Eco, Standby and Protection mode functions, the corresponding operating modes can be switched on in the associated thermostats or changed and transmitted to the bus by pressing a button.

### Example:

- Comfort The **Comfort** operating mode sets the room temperature to a temperature value predefined in the thermostat (e.g. comfort temperature 21°C) for comfort (presence).
- Standby The **Standby** operating mode reduces the room temperature after leaving the room (brief absence) to a value predefined in the thermostat (19°C, for example).
- Eco The **Eco** operating mode turns down the room temperature during holiday time (during long absence) to a value of 17°C defined in the thermostat.
- Frost protection The **Protection** operating mode reduces the heating circuit temperature to a minimum temperature of 7°C defined in the controller to protect against frost damage over night or during periods of extended absence.

**i** With underfloor heating, the change-over from "Comfort" to Standby is only noticeable after a certain period of time due to the sluggishness of the underfloor heating system.



The function of the status LED can also be set for the **Comfort**, **Standby**, **Eco** and **Protection** modes. The LED can be set to **Always off**, **Always on** or can be used as a **Thermostat** (Figure 59).



Figure 59: Operating mode status LED

When **Thermostat** is selected, the status LED for the button adopts the corresponding colour for the respective operating mode, as recorded in the thermostat.

Colour of status LED	Operating mode
orange	Comfort mode
green	Standby mode
blue	Eco mode
red	Protection mode

Table 5: Operating mode - Colour of status LED

If **Comfort** mode is set, for example, the status LED for the button pressed lights up in orange. The same behaviour ensues for the other modes.

#### 4.4.1 Function Comfort mode

Upon short press on the button the device sets the room temperature to a temperature value predefined in the thermostat (comfort temperature 21°C, for example) for comfort at presence.

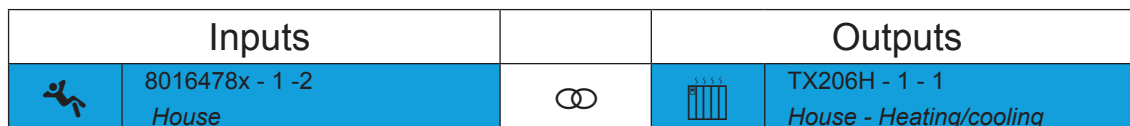

Figure 60: Linking **Comfort mode** function

#### 4.4.2 Function Standby mode

The device reduces the room temperature after leaving the room (brief absence) to a value predefined in the thermostat (19°C, for example).

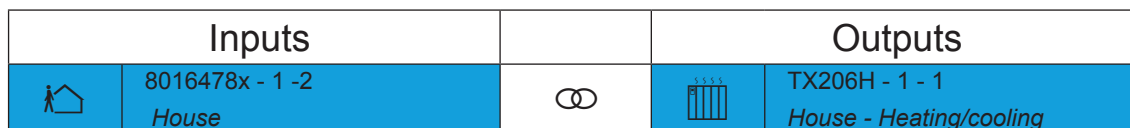

Figure 61: Linking **Standby mode** function

#### 4.4.3 Function Eco mode ☾

The device regulates the room temperature during holiday time (during long absence) to a value of 17°C defined in the thermostat.

Inputs			Outputs	
	8016478x - 1 -2 <i>House</i>			TX206H - 1 - 1 <i>House - Heating/cooling</i>

Figure 62: Linking **Eco mode** function

#### 4.4.4 Function Protection mode ❄

The device reduces the heating circuit temperature to a minimum temperature of 7°C defined in the controller to protect against frost damage over night or during periods of extended absence.

Inputs			Outputs	
	8016478x - 1 -2 <i>House</i>			TX206H - 1 - 1 <i>House - Heating/cooling</i>

Figure 63: Linking **Protection mode** function

#### 4.4.5 Function Setpoint offset ±x

The Setpoint offset function makes it possible to change the predefined setpoint temperature for the current operating mode in the thermostat by pressing a button.

Inputs			Outputs	
	8016478x - 1 -2 <i>House</i>			TX206H - 1 - 1 <i>House - Heating/cooling</i>

Figure 64: Linking **Setpoint offset** function

In addition, the status LED can be set to **Always on/off**; it is important to specify whether the value predefined in the thermostat should be permanently overwritten by the Setpoint offset (Figure 65).

Control	Output behaviour
0	Do <b>not</b> overwrite nominal temperature value
1	Overwrite nominal temperature value

Table 6: Overwrite nominal temperature value

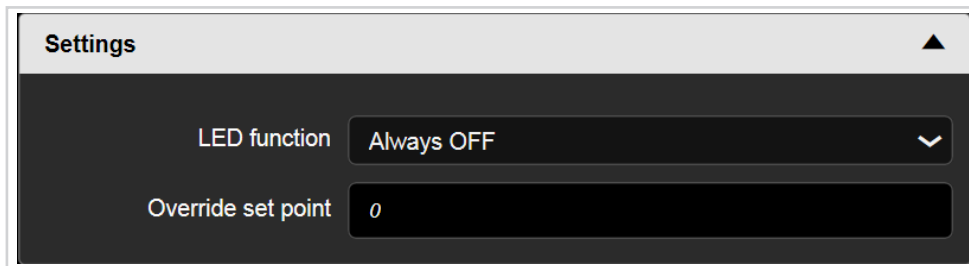

Figure 65: **Setpoint offset** settings

#### 4.4.6 Function Priority comfort toggle

With the **Priority comfort toggle** function, the operating mode which is currently running is interrupted and the thermostat is set to **Comfort** mode.



Inputs			Outputs	
	8016478x - 1 -2 <i>House</i>			TX206H - 1 - 1 <i>House - Heating/cooling</i>

Figure 66: Linking **Priority comfort toggle** function

Forced mode is switched on with a 1-command and off with a 0-command.

Control	Output behaviour
0	Switch off forced mode
1	Switch on forced mode

Table 7: Overwrite nominal temperature value

#### Example: Extending the Comfort operating mode

The **Priority comfort toggle** function can be used to prevent the previously set operating mode change-over and force the **Comfort** operating mode during events which are going to end later, for example. Once the event has finished, the forced operating mode is switched off and the actual operating mode is switched on. This is done with the same button (Toggle mode).

#### 4.4.7 Function Priority protection toggle

With the **Priority protection toggle** function, the operating mode which is currently running is interrupted and the thermostat is set to **Protection** mode.

Forced mode is switched on with a 1-command and off with a 0-command.



Inputs			Outputs	
	8016478x - 1 -2 <i>House</i>			TX206H - 1 - 1 <i>House - Heating/cooling</i>

Figure 67: Linking **Priority protection toggle** function

#### Example: Extending the Protection operating mode

The **Priority protection toggle** function can be used to prevent the previously set operating mode change-over and force the **Protection** operating mode during periods of extended absence. Once a person has returned, the forced operating mode is switched off and the actual operating mode is switched on. This is done with the same button (Toggle mode).

#### 4.4.8 Function Heating / cooling toggle

With this function, it is possible to change between heating and cooling each time the button is pressed.

If the **Heating** function is switched on, the **Cooling** function is switched on and the **Heating** function switched off when the button is pressed.





Inputs			Outputs	
	8016478x - 1 -2 <i>House</i>			TX206H - 1 - 1 <i>House - Heating/cooling</i>



Figure 68: Linking **Heating/cooling toggle** function

 To use this function, the heating/cooling system must be designed for heating and cooling operation.

#### 4.4.9 Scene function

The precise description of the **Scene** function can be found in Chapter „4.1.6 Scene function “.

#### 4.4.10 Automatic control deactivation toggle

The precise description of the **Deactivate automatic control toggle**  function can be found in chapter „4.3.9 Automatic control deactivation toggle “.

### 4.4.11 Overview of all possible linking combinations

The following overview shows all linking combination possibilities for the **Heating/cooling** function. It is worth noting that inputs can also be linked with inputs (depending on the function selection).

Linking			
Input			Input
 80660100 - 1 -1 House			Mode Comfort
			Mode Eco
			Mode Standby
			Protection mode
			Heating mode auto
			Heating mode switching
			Switching Comfort/Eco mode
			Switching Comfort/Standby mode
			Mode Protection Automatism
			$\pm \chi$ Setpoint Offset
			Priority Comfort mode
			Priority Protection mode
			Priority Comfort toggle
			Priority Protection toggle
			Window status
			Heating/cooling switching
			Heating/cooling toggle
			Mode Comfort Automatism
			Eco mode auto
			Mode Standby Automatism
Mode Protection Automatism			
Heating mode auto toggle			

Figure 69: Linking input – input **Heating/cooling**

Linking			
Input			Output
 80660100 - 1 -1 House			Shading control

Figure 70: Linking input – output **Heating/cooling**

## 5. Temperature sensor function parameters

In this following section, the configuration and parameterisation of the internal and external temperature sensor is described and presented.

- i** Both temperature sensors can be activated/deactivated independently from one another, which means that they can also be parameterised separately.

### 5.1 Internal temperature sensor

The device is directly fitted with a sensor for temperature measurement.

- i** The measured air can be transmitted directly to a KNX thermostat as a second measuring point (measurement result) and can be used to synchronise the global actual temperature (synchronisation in larger rooms).
- i** Room temperature recorded as a measurement result for a building visualisation



Inputs			Inputs	
	8016478x - 1 -9 House			80660100 - 1 -1 House

Figure 71: Linking input – input **Internal temperature sensor** function





Inputs			Outputs	
	8016478x - 1 -9 House			80660100 - 1 -1 House

Figure 72: Linking input – output **Internal temperature sensor** function

## 5.2 External temperature sensor

The external temperature sensor is a cable-based remote sensor that can be connected to the bus application unit (see accessories) directly. The temperature measured can therefore be transmitted to the BUS.

-  In addition, the externally measured temperature can be transmitted directly to a KNX thermostat as a second measuring point (measurement result) and can be used to synchronise the floor temperature (synchronisation in larger rooms).
-  The ambient temperature, for example, recorded as the measurement result when the push-button is installed in an unfavourable location (outside, etc.).



Inputs			Inputs	
	8016478x - 1 -9 House			80660100 - 1 -1 House

Figure 73: Linking input – input **External temperature sensor** function

When selecting an installation position for the device or the external sensor, observe the following:

- Integrating the push-button into multiple combinations should be avoided especially when a flush-mounted dimmer is also installed.
- The sensors should not be installed near to large electrical consumers (heat radiation).
- The device/sensor should not be installed near to heaters or cooling systems.
- The temperature sensor must be kept out of direct sunlight.
- Installing sensors on the inside of external walls may negatively influence the temperature measurement.
- Temperature sensors should be installed at least 30 cm away from doors and windows and at least 1.5 m above the floor.

The temperature is only actually controlled using the thermostat.

## 6. Appendix

### 6.1 Technical data

KNX medium	TP 1
Configuration mode	easy link
Rated voltage KNX	21 ... 32 V <sub>~</sub> SELV
Current consumption KNX	typ. 20 mA
KNX connection mode	AST user interface
Degree of protection	IP 20
Protection class	III
Operating temperature	-5 ... +45 °C
Storage/transport temperature	-20 ... +70 °C
Standards	EN 60669-2-1; EN 60669-1 EN 50428

### 6.2 Accessories

Bus application unit, flush-mounted	8004 00 01
Fernfühler	EK090

### 6.3 Warranty

We reserve the right to realise technical and formal changes to the product in the interest of technical progress.

Our products are under guarantee within the scope of the statutory provisions.

If you have a warranty claim, please contact the point of sale.



## 7. Table of Figures

Figure 1: Device overview .....	5
Figure 2: Button/input assignment – numbering in configuration tool S.1 .....	6
Figure 3: Button/input assignment – numbering in configuration tool R.x .....	7
Figure 4: Input/output signals Lighting function .....	9
Figure 5: Input/output signals Dimming function .....	10
Figure 6: Input/output signals Roller shutter function .....	11
Figure 7: Input/output signals Heating/cooling function .....	12
Figure 8: Device information.....	14
Figure 9: Colour choice status LED.....	14
Figure 10: Overview inputs/outputs .....	16
Figure 11: Function selection status LED .....	17
Figure 12: Select LED .....	17
Figure 13: Function selection Backlighting.....	18
Figure 14: LED backlighting push-button R.x (left) – S.1 (right).....	18
Figure 15: Switching off the status LED / backlighting .....	18
Figure 16: Function selection of the independent push-button .....	19
Figure 17: Functional overview lighting .....	20
Figure 18: Linking function <b>On - Off</b> .....	<b>20</b>
Figure 19: Linking Function <b>switching</b> .....	<b>21</b>
Figure 20: Linking <b>Toggle switch</b> function.....	21
Figure 21: Linking <b>Timer</b> function.....	21
Figure 22: Signal-time diagram for timer .....	21
Figure 23: Linking <b>Priority on toggle</b> function.....	22
Figure 24: Linking <b>Priority off toggle</b> function .....	22
Figure 25: Signal-time diagram for Priority .....	22
Figure 26: Linking <b>Scene</b> function.....	23
Figure 27: Entering the scene number .....	23
Figure 28: Scene call-up.....	23
Figure 29: Combination possibilities <b>Lighting</b> input – output.....	26
Figure 30: Functional overview <b>Dimming</b> .....	<b>27</b>
Figure 31: Linking <b>Dimming up (on)/down (off)</b> function .....	27
Figure 32: Linking <b>Dimming up/down</b> function .....	27
Figure 33: Linking <b>Dimming – dimming value</b> function.....	28
Figure 34: Set dimming value.....	28
Figure 35: Combination possibilities <b>Dimming</b> input – output.....	29
Figure 36: Functional overview <b>Roller shutter</b> .....	<b>30</b>
Figure 37: Blind position top final position 0 %.....	30
Figure 38: Blind position bottom final position .....	31
Figure 39: Adjust slat angle .....	31
Figure 40: Slat angle at the start of the movement towards the top final position .....	31
Figure 41: Slat angle for slats arranged vertically $\alpha = 90^\circ$ .....	32
Figure 42: Slat angle for slats arranged vertically $\alpha \approx 0^\circ$ .....	32
Figure 43: Slat angle when opening $\alpha \approx 180^\circ$ .....	32
Figure 44: Linking <b>Blind up/down</b> function.....	33

Figure 45: Linking <b>Roller shutter position</b> function .....	33
Figure 46: Entering the roller shutter position between 0 and 100 % .....	33
Figure 47: Linking <b>Slat angle</b> function .....	34
Figure 48: Entering the slat angle 0 - 100 % .....	34
Figure 49: Linking <b>Roller shutter and slat position</b> function .....	34
Figure 50: Entering the position/slat angle 0 - 100 % .....	34
Figure 51: Linking <b>Roller shutter up/down</b> function .....	35
Figure 52: Linking <b>Priority up toggle</b> function .....	35
Figure 53: Linking <b>Priority down toggle</b> function .....	35
Figure 54: Signal-time diagram for <b>Priority roller shutter/blind</b> .....	<b>35</b>
Figure 55: Linking <b>Automatic control deactivation toggle</b> function .....	36
Figure 56: Signal-time diagram for Automatic control deactivation .....	36
Figure 57: Combination possibilities <b>Roller shutter</b> input – output .....	39
Figure 58: Functional overview <b>Heating/cooling</b> .....	<b>40</b>
Figure 59: Operating mode status LED .....	41
Figure 60: Linking <b>Comfort mode</b> function .....	41
Figure 61: Linking <b>Standby mode</b> function .....	41
Figure 62: Linking <b>Eco mode</b> function .....	42
Figure 63: Linking <b>Protection mode</b> function .....	42
Figure 64: Linking <b>Setpoint offset</b> function .....	42
Figure 65: <b>Setpoint offset</b> settings .....	42
Figure 66: Linking <b>Priority comfort toggle</b> function .....	43
Figure 67: Linking <b>Priority protection toggle</b> function .....	43
Figure 68: Linking <b>Heating/cooling toggle</b> function .....	44
Figure 69: Linking input – input <b>Heating/cooling</b> .....	<b>45</b>
Figure 70: Linking input – output <b>Heating/cooling</b> .....	<b>45</b>
Figure 71: Linking input – input <b>Internal temperature sensor</b> function .....	46
Figure 72: Linking input – output <b>Internal temperature sensor</b> function .....	46
Figure 73: Linking input – input <b>External temperature sensor</b> function .....	47

## 8. List of tables

Table 1: Setting Colour of status LED.....	15
Table 2: Function of the status LED.....	17
Table 3: Function of the backlighting .....	18
Table 4: Function of the button .....	19
Table 5: Operating mode - Colour of status LED.....	41
Table 6: Overwrite nominal temperature value .....	42
Table 7: Overwrite nominal temperature value .....	43