

SM102E

Centrale de mesure
Multifunktionsmessgerät
Multi-function meter

- (FR) Notice d'instructions
- (DE) Bedienungsanleitung
- (GB) User instructions
- (IT) Istruzioni d'uso
- (NL) Gebruiksaanwijzing
- (ES) Instrucciones de uso
- (PT) Instruções de instalação



FR

Sommaire

Danger et avertissement	4
Opérations préalables	8
Présentation	10
Installation	12
Programmation.....	22
Utilisation	36
Fonction de test de raccordement.....	44
Assistance.....	52
Caractéristiques techniques	54
Lexique des abréviations	96

DE

Inhaltsverzeichnis

Gefahren und Sicherheitshinweise.....	4
Erste Schritte.....	8
Produktdarstellung.....	10
Installation	12
Konfiguration.....	22
Betrieb.....	36
Anschluss funktionstest	44
Hilfe	52
Technische Daten.....	60
Glossar der abkürzungen.....	97

GB

Contents

Danger and warning.....	5
Preliminary operations.....	8
Presentation	10
Installation	12
Programming.....	22
Operation	36
Connection test function	45
Assistance.....	52
Technical characteristics.....	66
Glossary of abbreviations.....	98

IT

Sommario

Pericolo e avvertimenti.....	5
Operazioni preliminari	8
Presentazione.....	10
Installazione.....	12
Programmazione	22
Utilizzo.....	36
Collegamento prova funzione	45
Assistenza	52
Caratteristiche tecniche	72
Elenco delle abbreviazioni.....	99

NL

Inhoud

Gevaar en waarschuwing	6
Voorafgaande handelingen	9
Presentatie	11
Installering	12
Programmering	22
Gebruik.....	36
Aansluiting test functie.....	45
Assistentie	53
Technische eigenschappen.....	78
Lijst van afkortingen	100

ES

Indice

Advertencia	6
Operaciones previas	9
Presentación	11
Instalación	12
Programación.....	22
Utilización.....	36
Conexión prueba función.....	46
Asistencia	53
Características técnicas.....	84
Léxico de las abreviaciones.....	101

PT

Índice

Perigo e aviso.....	7
Operações preliminares	9
Apresentação	11
Instalação.....	12
Programação.....	22
Utilização.....	36
Ligação teste função.....	46
Assistência	53
Características técnicas.....	90
Léxico das abreviaturas	102

FR

Le montage de ces matériels ne peut être effectué que par des professionnels.

Le non respect des indications de la présente notice ne saurait engager la responsabilité du constructeur.

Risque d'électrocution, de brûlures ou d'explosion

- l'installation et l'entretien de cet appareil ne doivent être effectués que par du personnel qualifié
- avant toute intervention sur l'appareil, coupez les entrées tensions, court-circuitez le secondaire de chaque transformateur de courant et coupez l'alimentation auxiliaire de l'appareil
- utilisez toujours un dispositif de détection de tension approprié pour confirmer l'absence de tension
- remplacez tous les dispositifs, les portes et les couvercles avant de mettre cet appareil sous tension
- utilisez toujours la tension assignée appropriée pour alimenter cet appareil.

Si ces précautions n'étaient pas respectées, cela pourrait entraîner des blessures graves.

Risque de détérioration de l'appareil

Veillez à respecter :

- la tension d'alimentation auxiliaire
- la fréquence du réseau 50 ou 60 Hz
- une tension maximum aux bornes des entrées tension de 500 V AC phase/phase ou 289 V AC phase neutre
- un courant maximum de 6 A aux bornes des entrées courants (I1, I2 et I3).

DE

Die Montage muss von einer Elektrofachkraft vorgenommen werden. Eine Nichteinhaltung der vorliegenden Sicherheitshinweise befreit den Hersteller von seiner Haftung.

Gefahr von Stromschlägen und Bränden

- Die Installation und Wartung dieses Gerätes darf nur von Elektrofachkräften vorgenommen werden.
- Vor jedem Eingriff am Gerät sind die Eingänge spannungslos zu schalten und die Sekundärseite jedes Stromwandlers kurzzuschließen und die Hilfsspannungsversorgung des Gerätes abzutrennen.
- Stets einen geeigneten Spannungsmesser verwenden, um sicherzugehen, dass keine Spannung anliegt.
- Alle Vorrichtungen, Türen und Deckel vor dem erneuten Einschalten des Gerätes wieder anbringen.
- Nur die vorgegebene Spannung zur Versorgung des Gerätes verwenden.

Eine Nichteinhaltung dieser Vorsichtsmaßnahmen kann zu schweren Verletzungen führen.

Gefahr einer Beschädigung des Gerätes

Bitte beachten Sie:

- Die Spannung der Hilfsspannungsversorgung,
- Die Netzfrequenz von 50 oder 60 Hz,
- Eine maximale Spannung an den Spannungsmess-eingängen von 500 V AC Aussenleiter/Aussenleiter und 289 V AC Aussenleiter/Neutralleiter,
- Einen maximalen Strom von 6 A an den Stromanschlussklemmen (I1, I2 und I3).

GB

This equipment must be mounted only by professionals.
The manufacturer shall not be held responsible for failure to comply with the instructions in this manual.

Risk of electrocution, burns or explosion

- the device must be installed and serviced only by qualified personnel
- prior to any work on or in the device, isolate the voltage inputs and auxiliary power supplies and short-circuit the secondary winding of all current transformers
- always use an appropriate voltage detection device to confirm the absence of voltage
- put all mechanisms, door and covers back in place before energising the device
- always supply the device with the correct rated voltage

Failure to take these precautions could cause serious injuries.

Risk of damaging device

Check the following:

- the voltage of the auxiliary power
- the frequency of the distribution system (50 or 60 Hz)
- the maximum voltage across the voltage-input terminals, (V1, V2, V3 and VN) 500 V AC phase-to-phase or 289 V AC phase-to-neutral
- a maximum current of 6 A on the current-input terminals (I1, I2 and I3).

IT

Questi materiali devono essere montati esclusivamente da professionisti. Il mancato rispetto delle indicazioni contenute nelle presenti istruzioni solleva il fabbricante da ogni responsabilità.

Rischi di folgorazione, ustioni o esplosione

- l'installazione e la manutenzione di questo apparecchio devono essere effettuate esclusivamente da personale qualificato
- prima di qualsiasi intervento sull'apparecchio, escludere gli ingressi di tensione, cortocircuitare il secondario di ciascun trasformatore di corrente ed escludere l'alimentazione ausiliaria dell'apparecchio
- utilizzare sempre un opportuno dispositivo di rilevamento di tensione per confermare l'assenza di tensione
- rimontare tutti i dispositivi, i portelli e i coperchi prima di mettere l'apparecchio sotto tensione
- per alimentare questo apparecchio, utilizzare sempre l'appropriata tensione assegnata

In caso di mancato rispetto di queste precauzioni, si potrebbero subire gravi ferite.

Rischi di deterioramento dell'apparecchio

Attenzione a rispettare:

- la tensione d'alimentazione ausiliaria
- la frequenza di rete a 50 o 60 Hz
- una tensione massima ai morsetti degli ingressi di tensione di 500 V AC fase/fase o 289 V AC fase neutro
- una corrente massima di 6 A ai morsetti degli ingressi di corrente (I1, I2 e I3).

NL

Enkel professionelen mogen deze materialen monteren.
De constructeur is in geen geval verantwoordelijk indien de aanwijzingen van de onderhavige gebruiksaanwijzing niet worden in acht genomen.

Gevaar voor elektrocutie, brandwonden of ontploffing

- enkel gekwalificeerd personeel mag dit toestel plaatsen en onderhouden
- vóór iedere tussenkomst op het toestel, alle spanningsingangen afsluiten, de secundaire van iedere stroomtransformator kortsluiten en de hulpvoeding van het toestel afsluiten
- gebruik steeds een geschikte spanningsmeter om na te gaan of het toestel wel degelijk buiten spanning staat
- alle onderdelen, deuren en deksels terugplaatsen alvorens het toestel onder spanning te zetten
- gebruik altijd de geschikte toegewezen spanning om dit toestel te voeden

Indien deze voorzorgsmaatregelen niet worden in acht genomen, kan dit ernstige verwondingen tot gevolg hebben.

Gevaar voor beschadiging van het toestel

Gelieve de volgende elementen in acht te nemen:

- de spanning van de hulpvoeding
- de netfrequentie van 50 of 60 Hz
- een maximale spanning op de klemmen van de spanningsingangen van 500 V AC fase/fase of 289 V AC fase/neuter
- een maximale stroom van 6 A op de klemmen van de stroomingangen (I1, I2 en I3).

ES

El montaje de esto materiales sólo puede ser efectuado por profesionales.
No respetar las indicaciones del presente manual exime de responsabilidad al fabricante.

Riesgo de electrocución, de quemaduras o de explosión

- la instalación y mantenimiento de este aparato debe ser efectuado por personal cualificado
- antes de cualquier intervención en el aparato, cortar sus entradas de tensión, corto-circuitar el secundario de cada transformador de intensidad y cortar la alimentación auxiliar de aparato
- utilizar siempre un dispositivo de detección de tensión apropiado para asegurar la ausencia de tensión
- volver a colocar todos los dispositivos, tapas y puertas antes de poner el aparato en tensión
- utilizar siempre la tensión asignada apropiada para alimentar el aparato

No respetar estas precauciones podría entrañar un serio riesgo de producir heridas graves.

Riesgo de deterioros de aparato

Vele por respetar:

- la tensión de alimentación auxiliar
- la frecuencia de la red 50 o 60 Hz
- una tensión máxima en las bornas de entradas de tensión (V1, V2, V3 y VN) de 500 V AC fase/fase o de 289 V AC entre fase y neutro
- intensidad máxima de 6 amperios en bornas de las entradas de intensidad (I1, I2 y I3).

PT

A montagem destes materiais só pode ser realizada por profissionais.
O não cumprimento das indicações deste manual não poderá imputar a responsabilidade do construtor.

Riscos de electrocussão, de queimaduras ou de explosão

- a instalação e a manutenção deste aparelho devem ser efectuadas unicamente por pessoal qualificado
- antes de qualquer intervenção no aparelho, cortar as entradas de tensões, curto-circuitar o secundário de cada transformador de corrente e cortar a alimentação auxiliar do aparelho
- utilizar sempre um dispositivo de detecção de tensão apropriado para confirmar a ausência de tensão
- colocar no sítio todos os dispositivos, as portas e as tampas antes de restabelecer a tensão no aparelho
- utilizar sempre a tensão de referência apropriada para alimentar o aparelho

Se estas precauções não forem respeitadas, poderão ocorrer ferimentos graves.

Riscos de deterioração do aparelho

Respeitar:

- a tensão de alimentação auxiliar
- a frequência da rede 50 ou 60 Hz
- uma tensão máxima nos terminais das entradas de tensão de 500 V AC fase/fase ou 289 V AC fase neutro
- uma corrente máxima de 6 A nos terminais das entradas de corrente (I1, I2 e I3).

FR

Pour la sécurité du personnel et du matériel, il est impératif de bien s'imprégner du contenu de cette notice avant la mise en service.

Au moment de la réception du colis contenant le **SM102E**, il est nécessaire de vérifier les points suivants :

- l'état de l'emballage,
- le produit n'a pas eu de dommage pendant le transport,
- la référence de l'appareil est conforme à votre commande,
- l'emballage comprend le produit équipé d'un bornier débrochable,
- une notice d'utilisation.

GB

For personnel and product safety please read the contents of these operating instructions carefully before connecting.

Check the following points as soon as you receive the **SM102E** package:

- the packing is in good condition,
- the product has not been damaged during transport,
- the product reference number is conform to your order,
- the package contains the product fitted with a pull-out terminal block,
- operating instructions.

DE

Für die Sicherheit von Personen und Anlagen lesen Sie dieses Handbuch aufmerksam durch, bevor das Gerät in Betrieb genommen wird.

Bei Empfang des Gerätes **SM102E** muß folgendes überprüft werden:

- Zustand der Verpackung,
- Sind Transportschäden zu melden,
- Entspricht der Packungsinhalt Ihrer Bestellung,
- Die Verpackung enthält das mit einer herausnehmbaren Klemmenleiste ausgestattete Produkt,
- Eine Bedienungsanleitung ist beigelegt.

IT

Per la sicurezza del personale e del materiale, è indispensabile leggere attentamente il contenuto del presente libretto prima della messa in servizio.

Al momento del ricevimento della scatola contenente il prodotto **SM102E**, è necessario verificare i seguenti punti:

- lo stato dell'imballo,
- la presenza di danneggiamenti o rotture dovuti al trasporto,
- se il numero di riferimento dell'apparecchio è conforme a quello della richiesta,
- l'imballaggio comprende il prodotto dotato di una morsettiera staccabile,
- la presenza istruzioni originale.

(NL)

Voor de veiligheid van het personeel en het materiaal is het van belang goed kennis te nemen van deze gebruiksaanwijzing voordat de apparatuur in gebruik wordt genomen.

Bij ontvangst van de doos met de product **SM102E** moeten de volgende punten gecontroleerd worden:

- de staat van de verpakking,
- of het product geen schade heeft geleden tijdens het transport,
- of de referentie van het toestel overeenkomt met de bestelling,
- de verpakking bevat een product uitgerust met een ontkoppelbaar aansluitblok,
- of de gebruiksaanwijzing aanwezig is.

(ES)

Para la seguridad del personal y del material, será imperativo conocer perfectamente el contenido de este manual antes de su puesta en funcionamiento.

Al recibir el paquete que contiene el producto **SM102E**, será necesario verificar los aspectos siguientes:

- estado del embalaje,
- que el producto no se haya dañado durante el transporte,
- que la referencia del Aparato esté conforme con su pedido,
- el embalaje incluye el producto equipado con una caja de bornes desenchufable,
- el manual de utilización.

(PT)

Para a segurança do pessoal e do material, convém inteirar-se bem do conteúdo deste manual antes da colocação em serviço.

Na altura da recepção da encomenda do produto **SM102E**, é necessário verificar os seguintes pontos:

- o estado da embalagem,
- se o produto não foi danificado durante o transporte,
- se a referência do Aparelho está acordo com a sua encomenda,
- dentro da embalagem encontrase realmente o produto equipado de um terminal descartável,
- se existe um manual de utilização.

FR

- ① Clavier 4 touches pour visualiser l'ensemble des mesures et modifier les paramètres de configuration
- ② Afficheur LCD rétroéclairé
- ③ Phase
- ④ Valeurs
- ⑤ Unité
- ⑥ Indicateur de comptage de l'énergie active

GB

- ① Key-pad with 4 dual-function keys (display or programming)
- ② Backlighted LCD display
- ③ Phase
- ④ Values
- ⑤ Unit
- ⑥ Energy metering indication

DE

- ① 4 Drucktaster mit doppelter Funktionalität (Anzeige oder Konfiguration)
- ② LCD-Anzeige mit Hintergrundbeleuchtung
- ③ Anzeige der Aussenleiter
- ④ Messwerte
- ⑤ Einheit
- ⑥ Anzeige zur Erfassung der Wirkleistung

IT

- ① Tastiera composta da 4 pulsanti a doppia funzionalità (visualizzazione o configurazione)
- ② Display LCD retroilluminato
- ③ Fase
- ④ Valori
- ⑤ Unità di misura
- ⑥ Indicatore di conteggio dell'energia attiva



Présentation - Produktdarstellung - Presentation - Presentazione - Presentatie - Presentación - Apresentação

NL

- ① Toetsenbord samengesteld uit 4 drukknoppen met dubbele functies (visualisatie of configuratie)
- ② LCD scherm met backlight
- ③ Fase
- ④ Waarden
- ⑤ Eenheid
- ⑥ Indication voor de meting van de actieve energie

PT

- ① Teclado composto de 4 botões de pressão de dupla funcionalidade (visualização ou configuração)
- ② Affiche Visualizador LCD retroiluminado ur LCD rétroéclairé
- ③ Fase
- ④ Valores
- ⑤ Unidade
- ⑥ Indicador de contagem da energia activa

ES

- ① Teclado compuesto por 4 teclas de doble función (visualización o configuración)
- ② Indicador LCD retroiluminado
- ③ Fase
- ④ Valores
- ⑤ Unidad
- ⑥ Indicador de contaje de energía



Installation - Installation - Installation - Installazione - Installering - Instalación - Instalação

FR

Recommandations :

- éviter la proximité avec des systèmes générateurs de perturbations électromagnétiques,
- éviter les vibrations comportant des accélérations supérieures à 1 g pour des fréquences inférieures à 60 Hz.

DE

Empfehlungen:

- vermeiden Sie die Nähe von Systemen, die elektromagnetische Störungen erzeugen können.
- vermeiden Sie außerdem mechanische Schwingungen mit Beschleunigungen von über 1 g bei Frequenzen unter 60 Hz.

GB

Recommendations:

- avoid proximity to systems which generate electromagnetic interference
- avoid vibrations with accelerations in excess of 1 g for frequencies below 60 Hz.

IT

Prescrizioni:

- evitare la vicinanza con sistemi generatori di perturbazioni elettromagnetiche.
- evitare le vibrazioni che comportino delle accelerazioni superiori a 1 g per delle frequenze inferiori a 60 Hz.

NL

Aanbevelingen:

- de nabijheid vermijden van systemen die elektromagnetische storingen opwekken.
- trillingen vermijden met versnellingen boven 1 g voor frequenties lager dan 60 Hz.

ES

Recomendaciones:

- evitar la proximidad con los sistemas generadores de perturbaciones electromagnéticas
- evitar las vibraciones que provocan aceleraciones superiores a 1 g para frecuencias inferiores a 60 Hz.

PT

Recomendações:

- evite a proximidade com sistemas geradores de perturbações electromagnéticas
- evite as vibrações com acelerações superiores a 1 g para frequências inferiores a 60 Hz.

Installation - Installation - Installation - Installazione -
Instalering - Instalación - Instalação

(FR) Plan de découpe

(DE) Ausschnittmaße

(GB) Cut-out diagram

(IT) Dima di foratura

(NL) Snijplan

(ES) Dimensiones

(PT) Plano de cortes

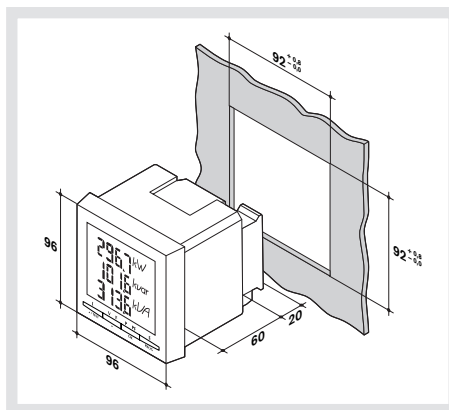

(FR) Montage

(DE) Montage

(GB) Mounting

(IT) Montaggio

(NL) Montage

(ES) Montaje

(PT) Montagem

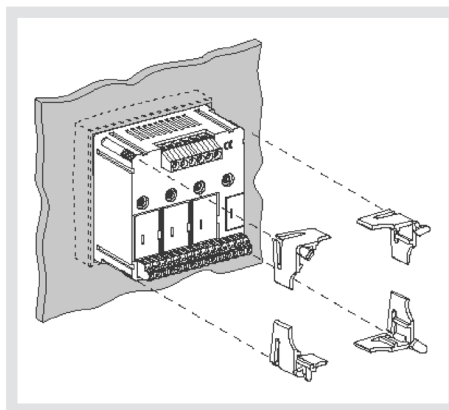

Installation - Installation - Installation - Installazione - Installing - Instalación - Instalação

FR

Raccordement

Le couple de serrage maximum de chaque vis est de 0,4 Nm.

Lors d'une déconnexion du produit **SM102E**, il est indispensable de court-circuiter les secondaires de chaque transformateur de courant.

DE

Anschluß

Max. Anziehdrehmoment für die jeweiligen Schrauben: 0,4 Nm.

Wird das Produkt **SM102E** abgeklemmt, so müssen die Sekundärseiten der jeweiligen Stromwandler kurzgeschlossen werden.

GB

Connection

The maximum coupling torque for each screw is 0.4 Nm.

Each CT's secondary winding must be short-circuited when disconnecting the **SM102E** product.

IT

Collegamento

La coppia di serraggio massima dei morsetti è di 0,4 Nm.

Al momento del collegamento del prodotto **SM102E**, è indispensabile cortocircuitare le uscite secondarie di ogni trasformatore di corrente.

NL

Aansluiting

Het maximale aantrekkoppel van elke schroef is 0,4 Nm.

Bij het ontkoppelen van de product **SM102E** is het noodzakelijk de secundaire van elke stroomtransformator kort te sluiten.

ES

Parte trasera

El par de apriete máximo para cada tornillo es de 0,4 Nm.

En caso de desconexión del producto **SM102E**, es indispensable cortocircuitar los secundarios de cada transformador de intensidad.

PT

Ligação

O binário de aperto máximo de cada parafuso é de 0,4 Nm.

Durante uma desconexão do produto **SM102E**, é indispensável curto-circuitar os secundários de cada transformador de corrente.

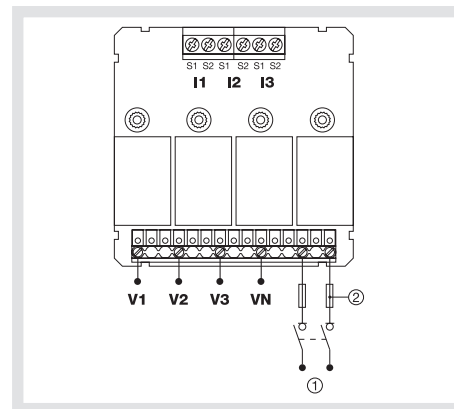

① Aux. : IEC /CE

110... 400V AC
120... 350V DC

② Fus. : 0.5 A gG / BS 88 2A gG / 0.5 A class CC

FR

Recommandations

Le produit **SM102E** peut être équipé du module option "Sortie impulsion" (réf : **SM200**).

1 sortie qui peut être affectée en mode :

- impulsionnelle : associé aux comptages des énergies kWh et kvarh
- alarme : pour la surveillance des grandeurs électriques
- commande : pour le pilotage à distance d'organe de coupure ou de commande.

(Notice d'utilisation réf : **6S5072**)

GB

Option module

The **SM102E** product can be fitted with option module "Pulse output" (ref: **SM200**).

1 delete output which can be configured for any of the below functions:

- Pulse: Output can be configured to represent energy in kWh or kvarh.
- Alarm: Single alarm output can be configured to monitor limits of electrical values (current, voltage, frequency, etc.).
- Remote control of external switching- or control devices.

(User manual ref: **6S5072**)

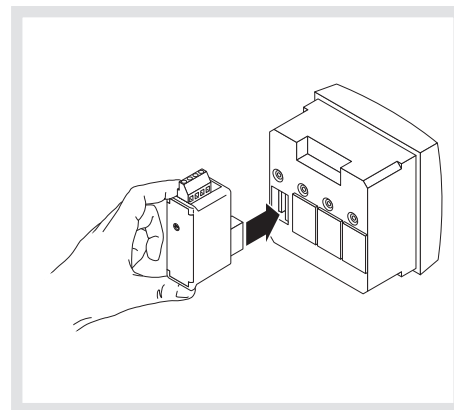

DE

Optionsmodule

Das Gerät **SM102E** kann mit Optionsmodule ausgestattet werden "Impulsausgang" (Best.-Nr.: **SM200**).

1 Ausgang konfigurierbar auf:

- Impuls: zur Energiezählung kWh und kvarh
- Alarm: zur Überwachung der elektrischen Kenndaten
- Steuerung: zur Fernbedienung elektrischer Schalt- oder Steuerungsgeräte.

(Bedienungsanleitung Best.-Nr.: **6S5072**)

IT

Modulo opzione

Il prodotto **SM102E** possono essere dotati del modulo opzione "Uscita a impulsi" (rif: **SM200**).

1 uscita configurabile in modo:

- impulsi: associato al conteggio delle energie kWh e kvarh
- allarme: per la sorveglianza delle grandezze elettriche
- comando: per il comando a distanza di sistemi di apertura o di comando.

(Istruzioni rif: **6S5072**)

NL

Optimodule

De product **SM102E** kunnen worden uitgerust met optimodule "Impulsuitgang" (ref: **SM200**). 1 uitgang die kan toegekend worden naar keuze in:

- impulsmode: geassocieerd met de telling van actieve en reactieve energie kWh en kvarh
- alarmmode: voor de bewaking van elektrische grootheden
- bediening: voor het sturen op afstand van een toestel om te onderbreken of bedienen.

(Gebruikshandleiding ref: **6S5072**)

PT

Module opção

Os produto **SM102E** podem estar equipados com module opção "Saída de impulso" (ref: **SM200**).

- 1 saída que pode ser afectada em modo:
- impulsional: associado às contagens das energias kWh e kvarh
 - alarme: para o controlo das grandezas eléctricas
 - comando: para controlo à distância de órgão de corte ou de comando.

(Manual de utilização ref: **6S5072**)

ES

Modulo opción

Los producto **SM102E** pueden estar equipados con modulo opción "Salida de impulsos" (ref: **SM200**).

1 salida configurable:

- impulsos: configurable para las energías kWh y kvarh
- Alarma: vigilancia de los parámetros
- Control remoto: para el mando a distancia del aparato de corte.

(Manual de instrucciones ref: **6S5072**)

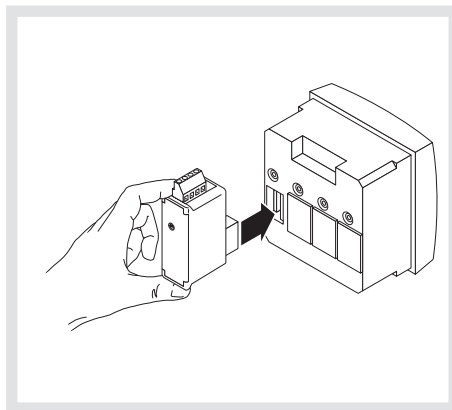

Installation - Installation - Installation - Installazione -
Installering - Instalación - Instalação

FR

Réseau triphasé déséquilibré (3NBL / 4NBL)

La solution avec 2 TC diminue de 0,5 % la précision de la phase dont le courant est déduit par calcul vectoriel.

 En régime IT, ne pas raccorder les secondaires de TC à la terre.

IT

Rete trifase non equilibrata (3NBL/4NBL)

La soluzione con 2 TA diminuisce di 0,5 % la precisione di misura delle fasi da cui la corrente viene dedotta in maniera vettoriale.

 En régime IT, no enchufar los secundarios de TC a la toma de tierra.

DE

Dreiphasennetz mit ungleicher Belastung (3NBL/4NBL)

Die Lösung mit 2 Stromwandlern verringert um ca. 0,5 % die Genauigkeit des Aussenleitersstromes, der vektoriell errechnet wird.

 Bei einer Netzform Typ IT-System Sekundarseite den Stromwandler nicht erden.

NL

Onevenwichtig driefasennet (3NBL/4NBL)

De oplossing met 2 TC vermindert de precisie van de fase waarvan de stroom vectorieel verminderd wordt, met 0,5 %.

 In IT-net de secundaires van de stroomtransformator niet verbinden met de aarding.

GB

Unbalanced three-phase network (3NBL/4NBL)

The solution with 2 CTs with the 2nd and 3rd phase current calculated via vectoral summation, results in an 0.5% reduction in phase accuracy.

 In IT load, do not connect the secondary of TC with the earth.

ES

Red trifásica desequilibrada (3NBL/4NBL)

La solución con 2 TC disminuye de 0,5 % la precisión de las medición de las fases sin transformador ya que el valor de la intensidad se deduce vectorialmente.

⚠ En esquema IT, no conectar los secundarios de los TC a tierra.

PT

Rede trifásica desequilibrada (3NBL/4NBL)

A solução com 2 TC diminui de 0,5 % a precisão da fase cuja corrente é deduzida vectorialmente.

⚠ Em regime IT, não conectar os secundários de TC à terra

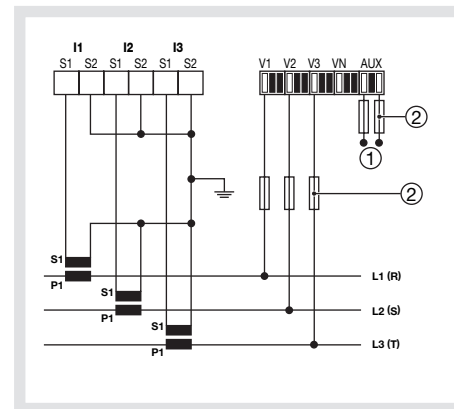
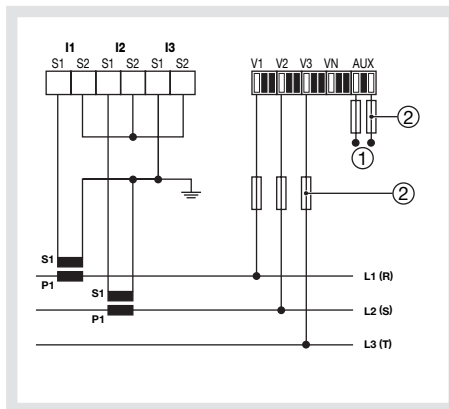
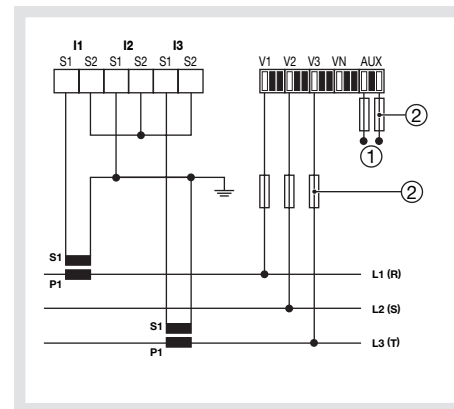
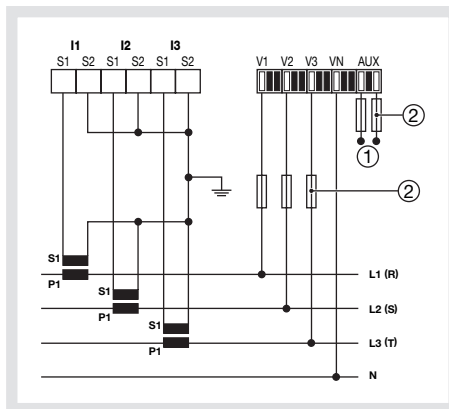

① Aux. : IEC /CE

110... 400V AC
 120... 350V DC

② Fus. : 0.5 A gG / BS 88 2A gG / 0.5 A class CC

Installation - Installation - Installation - Installazione - Installing - Instalación - Instalação

(FR)

Réseau triphasé équilibré (3BL/4BL)

La solution avec 1 TC diminue de 0,5 % la précision des phases dont le courant est déduit par calcul vectoriel.

(DE)

Dreiphasennetz mit gleicher Belastung (3BL/4BL)

Die Lösung mit 1 Stromwandler verringert um ca. 0,5 % die Genauigkeit der Aussenleiters-tröme, die vektoriell errechnet werden.

(GB)

Balanced three-phase network (3BL/4BL)

The solution using one CT, with the 3rd phase current calculated via vectoral summation, results in an 0.5% reduction in phase accuracy.

(IT)

Rete trifase equilibrata (3BL/4BL)

La soluzione con 1 TA diminuisce di 0,5 % la precisione di misura della fase da cui la corrente viene dedotta in maniera vettoriale.

(NL)

Evenwichtig driefasennet (3BL/4BL)

De oplossing met 1 TC vermindert de precisie van de fases waarvan de stroom vectorieel verminderd wordt, met 0,5 %.

(ES)

Red trifásica equilibrada (3BL/4BL)

La solución con 1 TC disminuye de 0,5 % la precisión de las medición de las fases sin transformador ya que el valor de la intensidad se deduce vectorialmente.

(PT)

Rede trifásica desequilibrada (3BL/4BL)

A solução com 1 TC diminui de 0,5 % a precisão da fase cuja corrente é deduzida vectorialmente.

① Aux. : IEC /CE

110... 400V AC
120... 350V DC

② Fus. : 0.5 A gG / BS 88 2A gG / 0.5 A class CC

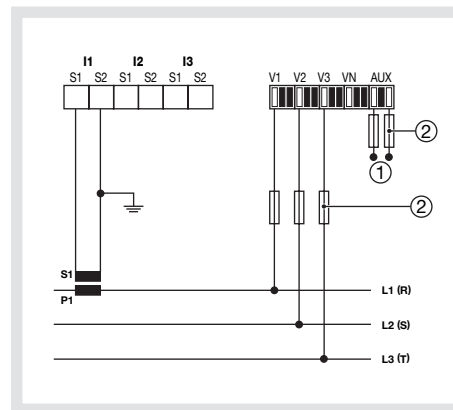
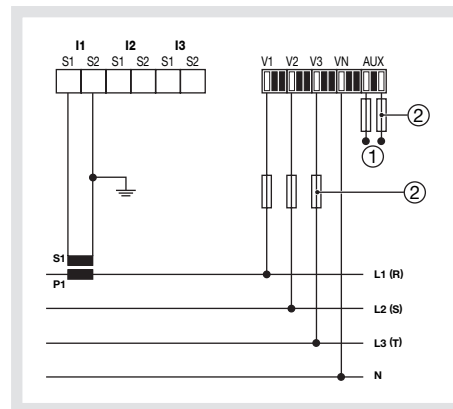

Installation - Installation - Installation - Installazione -
 Installing - Instalación - Instalação

- Ⓡ Réseau biphasé (2BL)
- Ⓡ Zweiphasennetz (2BL)
- Ⓡ Two-phase network (2BL)
- Ⓡ Rete bifase (2BL)
- Ⓡ Tweefasennet (2BL)
- Ⓡ Red bifásica (2BL)
- Ⓡ Rede bifásica (2BL)

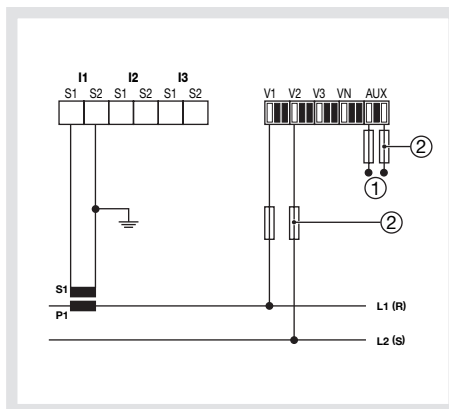

- ① Aux.: IEC /CE 110... 400V AC
120... 350V DC
- ② Fus.: 0.5 A gG / BS 88 2A gG / 0.5 A class CC

- Ⓡ Réseau monophasé (1BL)
- Ⓡ Einphasennetz (1BL)
- Ⓡ Single-phase network (1BL)
- Ⓡ Rete monofase (1BL)
- Ⓡ Enkelfasennet (1BL)
- Ⓡ Red monofásica (1BL)
- Ⓡ Rede monofásica (1BL)

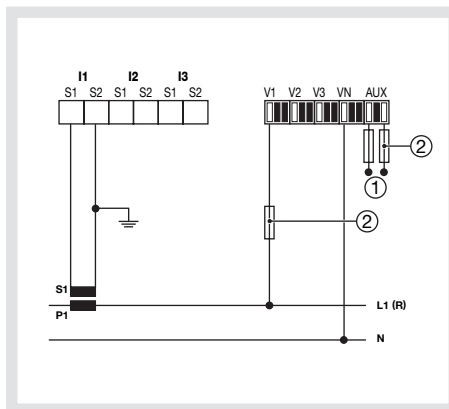

- ① Aux.: IEC /CE 110... 400V AC
120... 350V DC
- ② Fus.: 0.5 A gG / BS 88 2A gG / 0.5 A class CC

Programmation - Konfiguration - Programming - Programmazione - Programmering- Programación - Programação

- Ⓡ Menu programmation
- Ⓝ Programmierungsmenü
- Ⓜ Programming menu
- Ⓡ Menu programmazione
- Ⓝ Programmatie menu
- Ⓝ Programación menú
- Ⓝ Programação menu

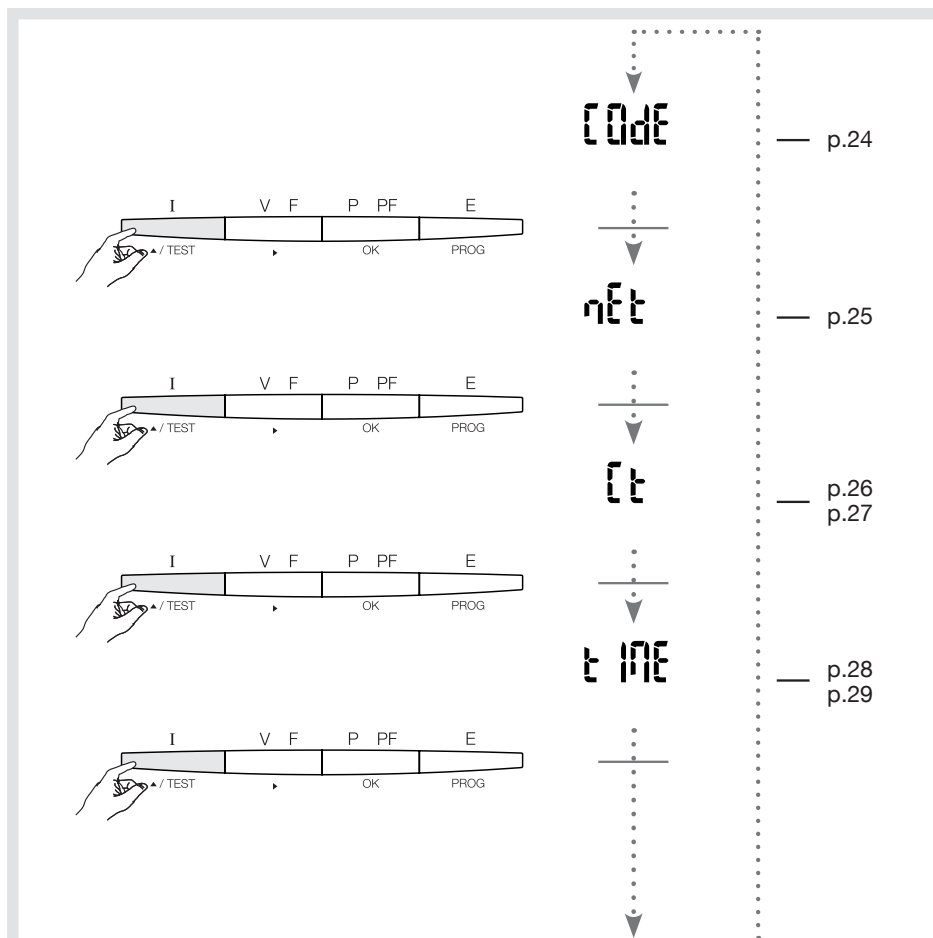

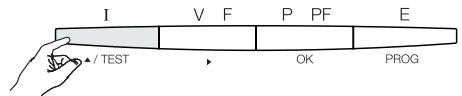

rSEt

p.30
p.31

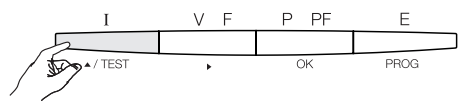

bAC
LIt

p.32

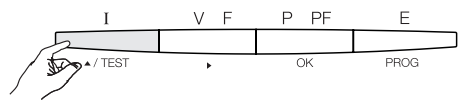

...

p.33

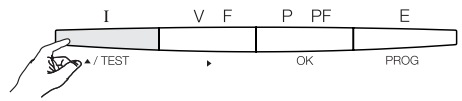

SOFT

p.33

Programmation - Konfiguration - Programming - Programmazione - Programmering- Programación - Programação

- Ⓡ **FR Entrer en programmation**
COdE = 100
- Ⓡ **DE Zur Konfigurationsebene**
COdE = 100
- Ⓡ **GB Acces to programming mode**
COdE = 100
- Ⓡ **IT Accesso alla programmazione**
COdE = 100
- Ⓡ **NL Overgaan tot programmeermodus**
COdE = 100
- Ⓡ **ES Entrar en modo programación**
COdE = 100
- Ⓡ **PT Entrar em modo programação**
COdE = 100

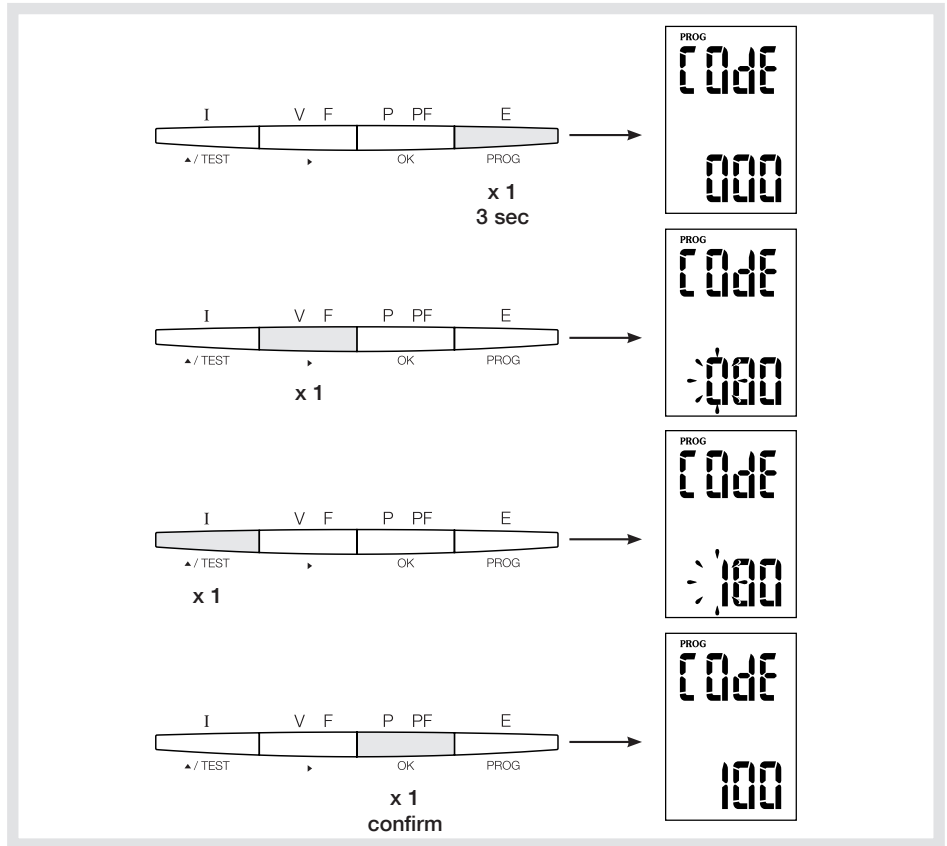

Programmation - Konfiguration - Programming - Programmazione -
 Programmering- Programación - Programação

FR Réseau
 Exemple : nEt = 3NBL

DE Netzwerk
 Beispiel: nEt = 3NBL

GB Network
 Example : nEt = 3NBL

IT Rete
 Esempio: nEt = 3NBL

NL Network
 Voorbeeld: nEt = 3NBL

ES Red
 Ejemplo: nEt = 3NBL

PT Rede
 Exemplo: nEt = 3NBL

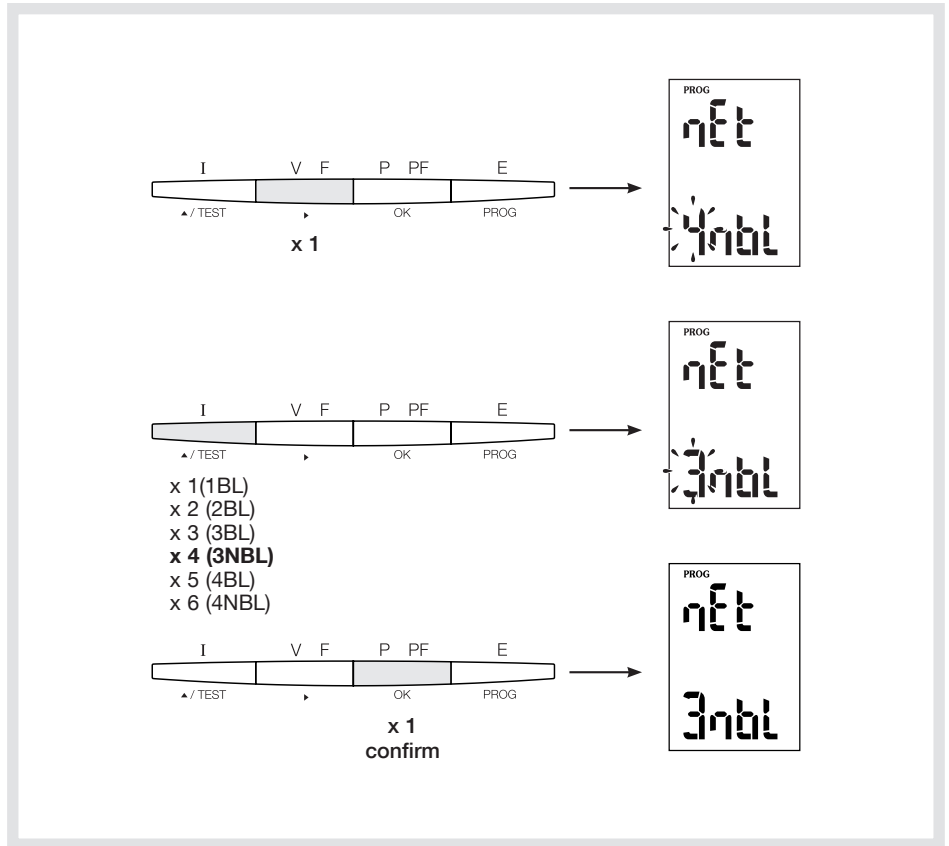

Programmation - Konfiguration - Programming - Programmazione - Programmering- Programación - Programação

(FR) Transformateurs de courant

Exemple : Ct = 1200 / 5A

(DE) Stromwandler

Beispiel: Ct = 1200 / 5A

(GB) Current transformers

Example : Ct = 1200 / 5A

(IT) Transformatore di corrente

Esempio: Ct = 1200 / 5A

(NL) Stroomtransformator

Voorbeeld: Ct = 1200 / 5A

(ES) Transformador de corriente

Ejemplo: Ct = 1200 / 5A

(PT) Transformador de corrente

Exemplo: Ct = 1200 / 5A

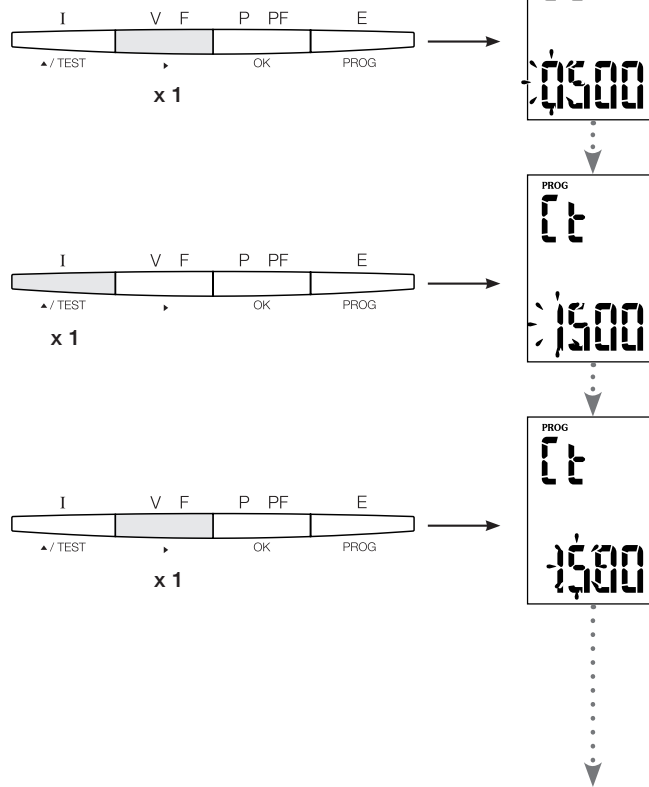

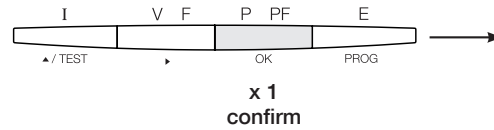
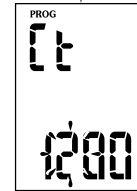
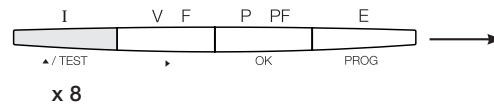

Programmation - Konfiguration - Programming - Programmazione - Programmering- Programación - Programação

- Ⓡ **FR** **Intégration des courants**
Exemple : tIME = 20 min
- Ⓡ **DE** **Integrationszeit für Ströme**
Beispiel: tIME = 20 min
- Ⓡ **GB** **Integration time of currents**
Example : tIME = 20 min
- Ⓡ **IT** **Integrazione delle correnti**
Esempio: tIME = 20 min
- Ⓡ **NL** **Integratietijd van de stromen**
Voorbeeld: tIME = 20 min
- Ⓡ **ES** **Integración de las intensidades**
Ejemplo: tIME = 20 min
- Ⓡ **PT** **Integração das cotentes**
Exemplo: tIME = 20 min

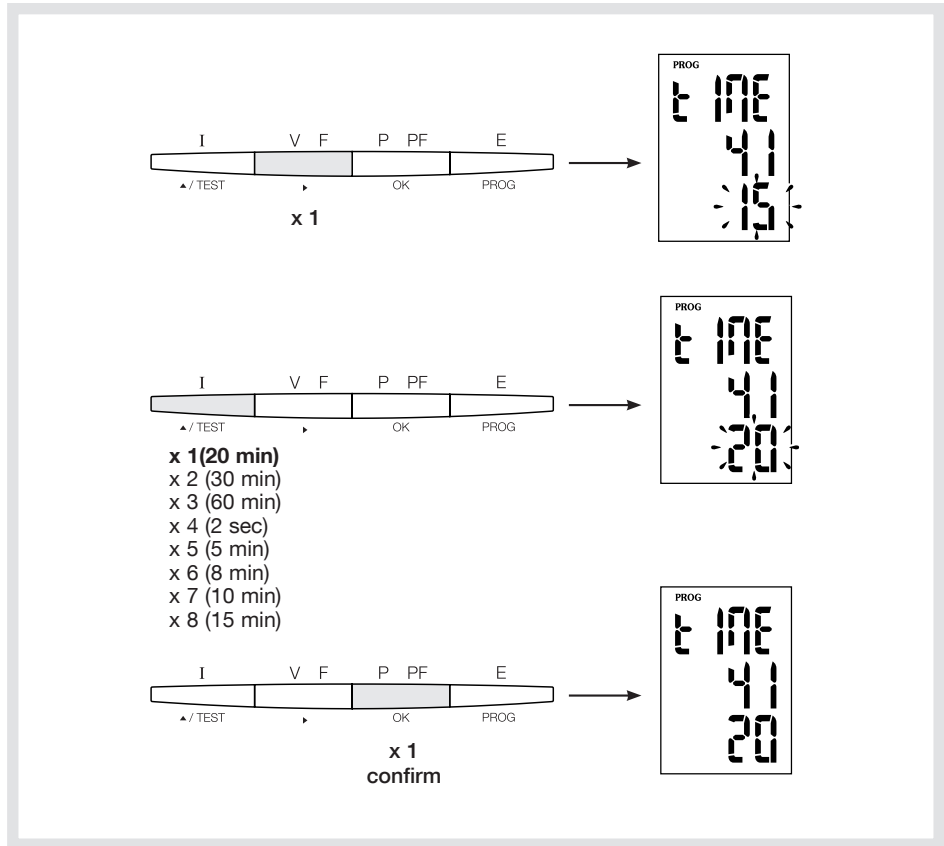

Programmation - Konfiguration - Programming - Programmazione - Programmering- Programación - Programação

(FR) Intégration de la puissance active

Exemple : tIME = 20 min

(DE) Integrationszeit der Wirkleistung

Beispiel: tIME = 20 min

(GB) Integration for active power time

Example : tIME = 20 min

(IT) Integrazione potenza attiva

Esempio: tIME = 20 min

(NL) Integratietijd van de actief vermogen

Voorbeeld: tIME = 20 min

(ES) Integración de las potencia activa

Ejemplo: tIME = 20 min

(PT) Integração das potência activa

Exemplo: tIME = 20 min

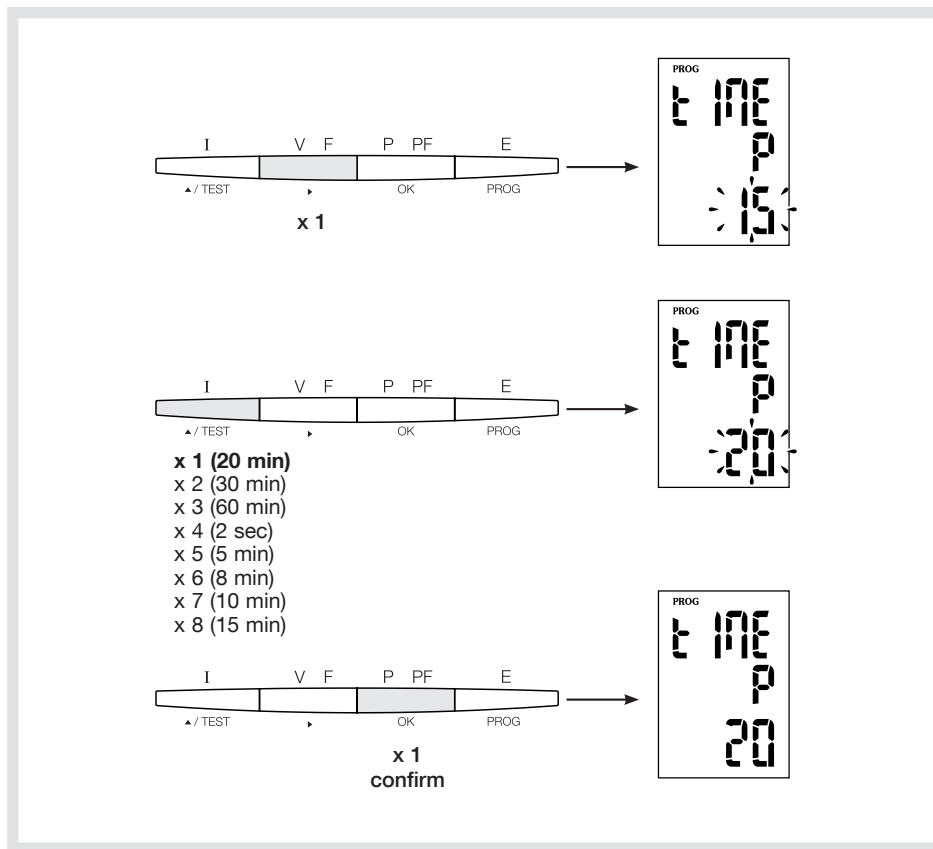

Programmation - Konfiguration - Programming - Programmazione - Programmering - Programación - Programação

FR Remise à zéro
Exemple : rSET = Ea

DE Reset
Beispiel: rSET = Ea

GB Reset to zero
Example : rSET = Ea

IT Azzeramento
Esempio: rSET = Ea

NL Reset
Voorbeeld: rSET = Ea

ES Volver a cero
Ejemplo: rSET = Ea

PT Colocações a zero
Exemplo: rSET = Ea

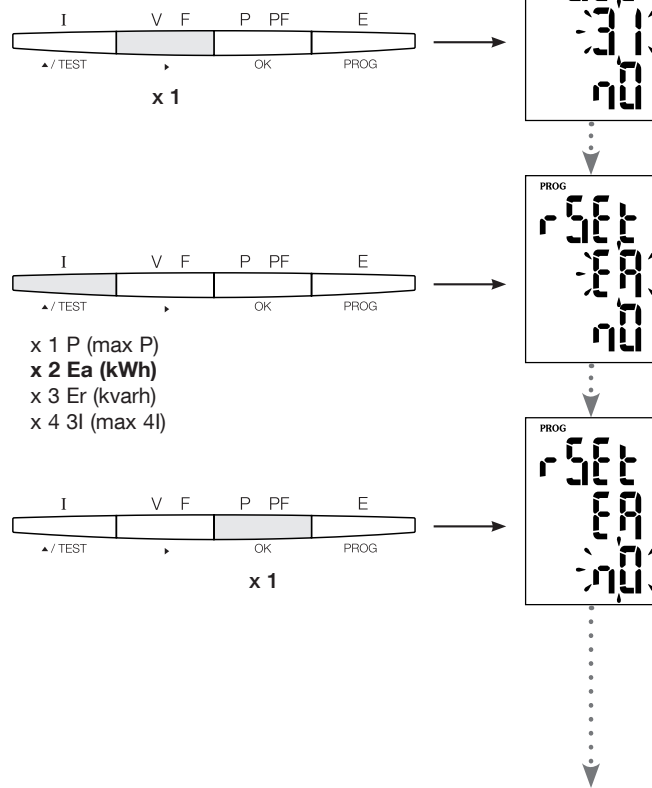

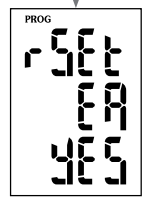
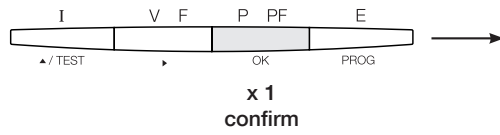
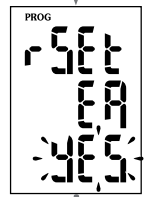
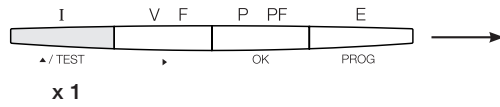

Programmation - Konfiguration - Programming - Programmazione - Programmering- Programación - Programação

- Ⓡ **Rétroéclairage**
Exemple : bACLIt = U
- Ⓡ **LCD Anzeige mit Hintergrundbeleuchtung**
Beispiel: bACLIt = U
- Ⓡ **Backlight LCD display**
Example : bACLIt = U
- Ⓡ **Retroilluminato**
Eempio: bACLIt = U
- Ⓡ **LCD met backlight**
Voorbeeld: bACLIt = U
- Ⓡ **Retroiluminación**
Ejemplo: bACLIt = U
- Ⓡ **Retroiluminação**
Exemplo: bACLIt = U

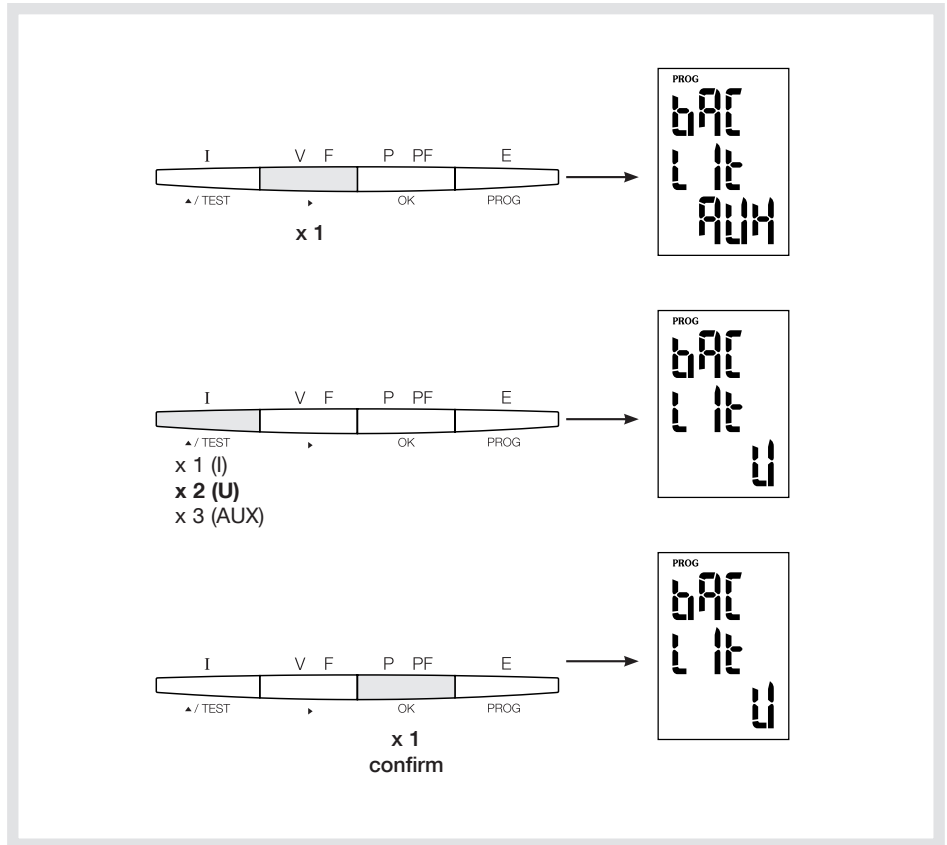

Programmation - Konfiguration - Programming - Programmazione - Programmering- Programación - Programação

(FR) Numéro de Série
Exemple : 05312784623

(DE) Seriennummer
Beispiel: 05312784623

(GB) Serial number
Example : 05312784623

(IT) Numero di serie
Esempio: 05312784623

(NL) Seriennummer
Voorbeeld: 05312784623

(ES) Número de serie
Ejemplo: 05312784623

(PT) Número de serie
Exemplo: 05312784623

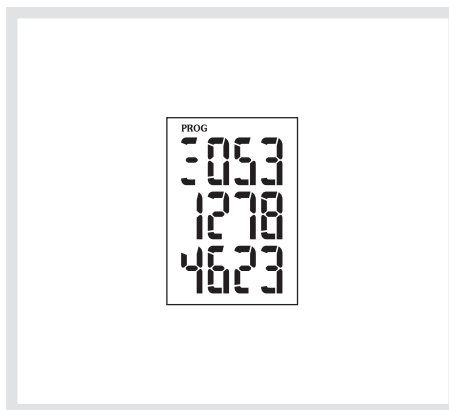

(FR) Version logiciel

(DE) Softwareversion

(GB) Software version

(IT) Versione software

(NL) Softwareversie

(ES) Versión de software

(PT) Versão do software

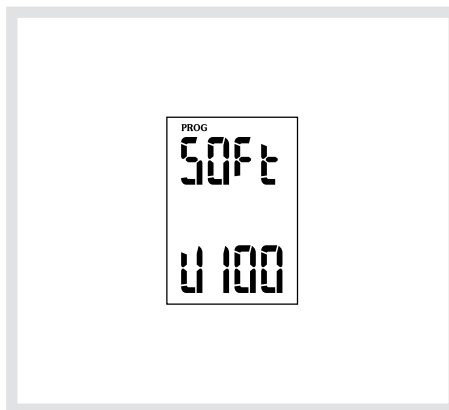

Programmation - Konfiguration - Programming - Programmazione -
Programmering- Programación - Programação

- Ⓡ FR Quitter la programmation
- Ⓡ DE Konfigurationsebene verlassen
- Ⓡ GB To quit programming
- Ⓡ IT Per abbandonare la programmazione
- Ⓡ NL Om vit pogrammering te gaan
- Ⓡ ES Para salirde la programación
- Ⓡ PT Para sair da programação

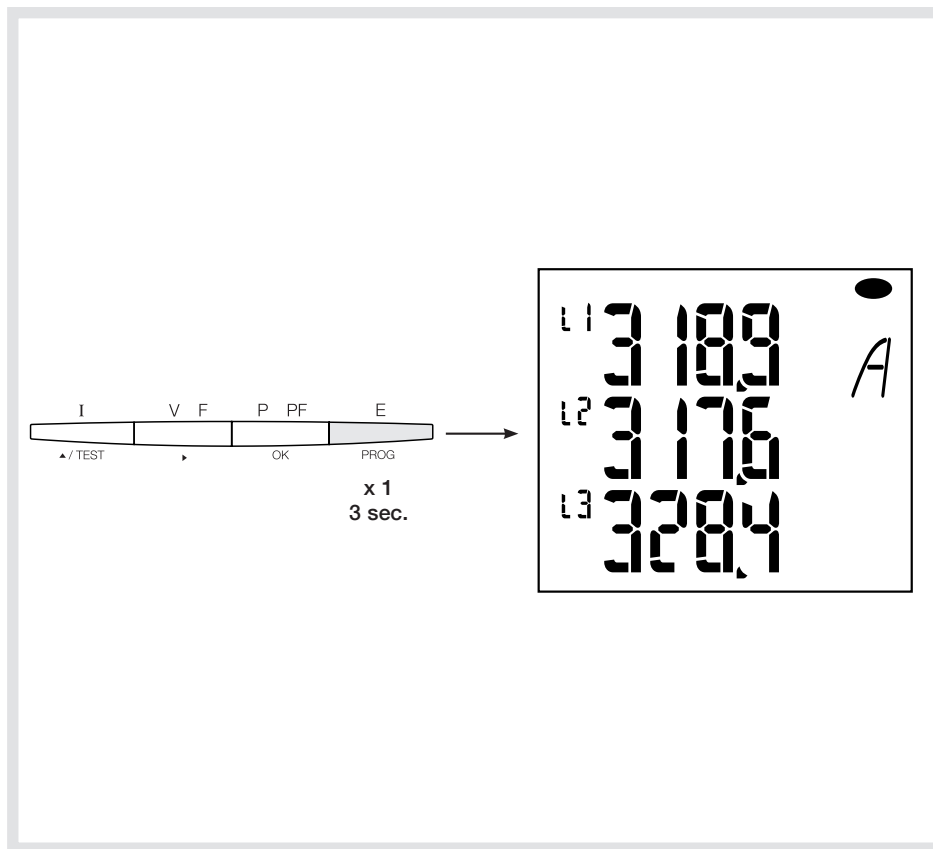

I - Current

x 1

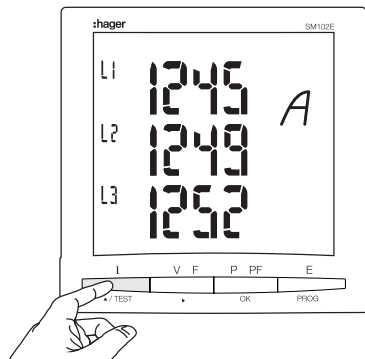

x 3

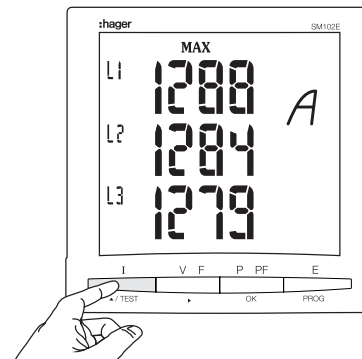

x 2

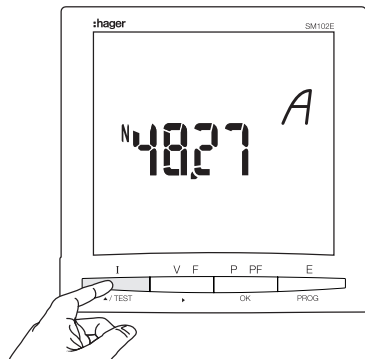

x 4

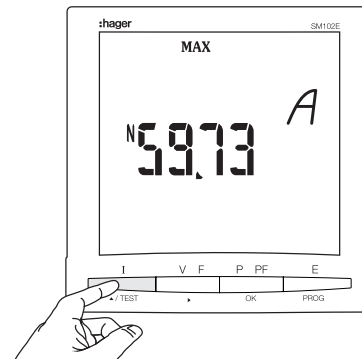

x 5

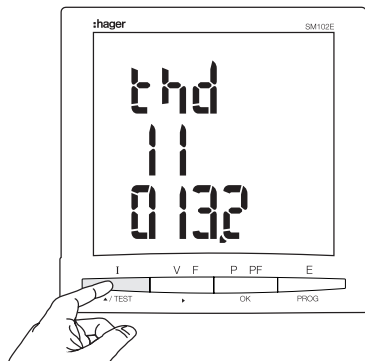

x 7

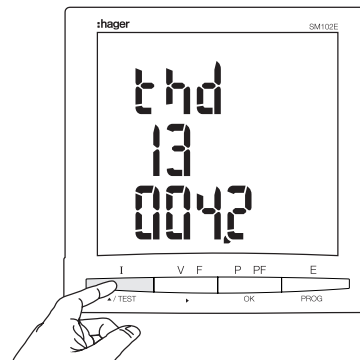

x 6

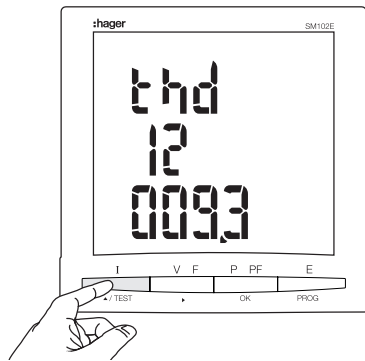

V/F - Voltage/Frequency

x 1

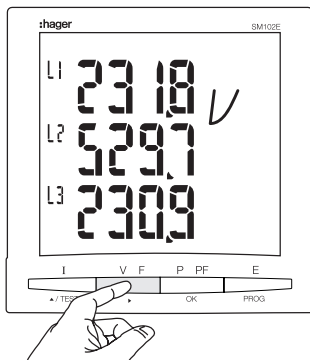

x 2

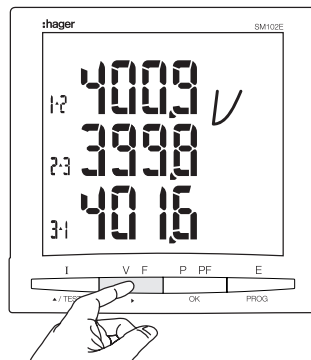

x 3

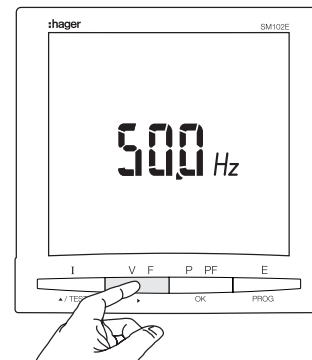

x 4

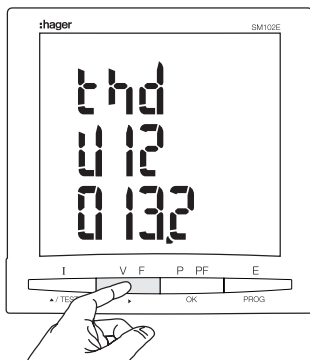

x 5

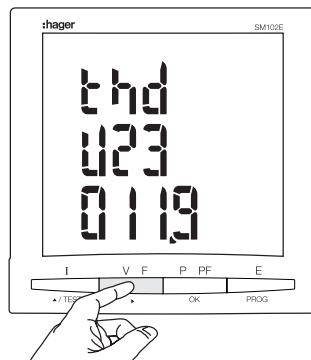

x 6

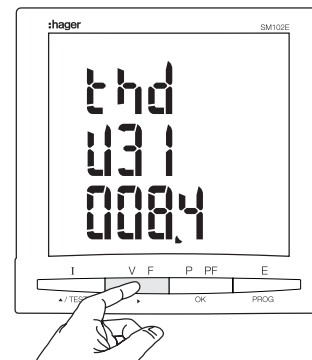

x 7

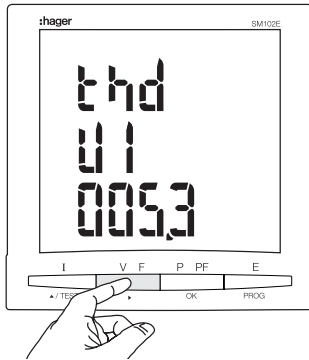

x 8

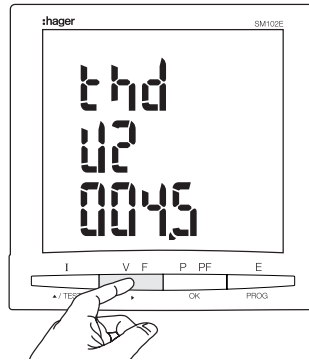

x 9

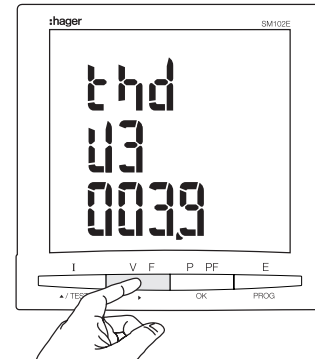

P/PF - Power/Power factory

x 1

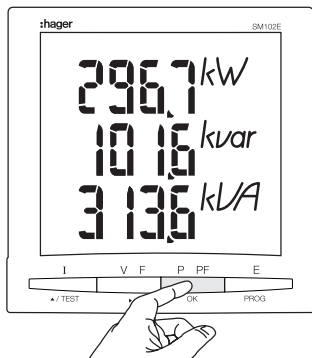

x 3

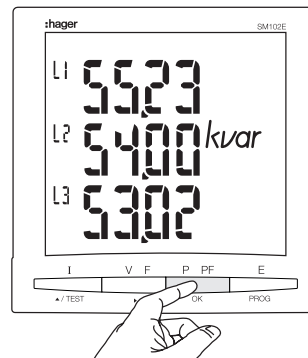

x 2

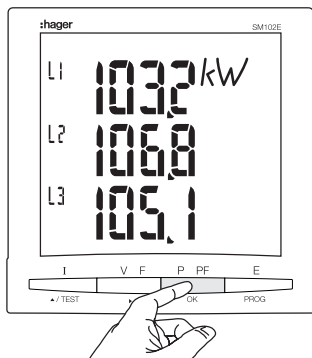

x 4

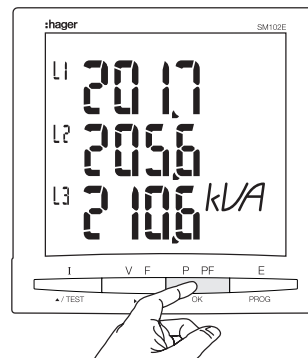

x 5

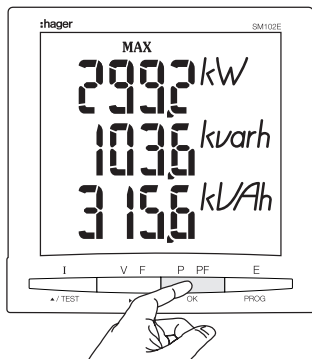

x 7

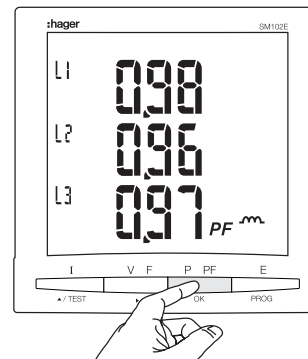

x 6

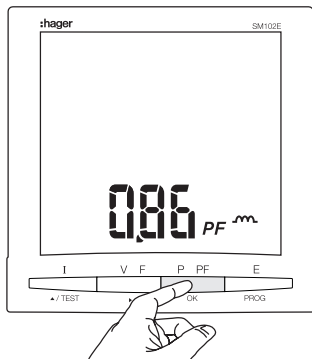

E - Energy

x 1

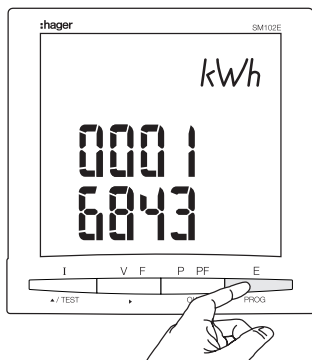

x 2

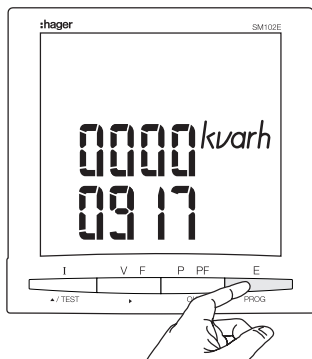

Fonction de test du raccordement - Anschluss Funktionstest - Connection test function - Collegamento prova funzione - Aansluiting test functie - Conexión prueba función - Ligação teste função

FR

Lors du test, le produit **SM102E** doit avoir du courant et de la tension sur chacune des phases. De plus, cette fonction considère que le FP de l'installation est compris entre $0,6 < FP < 1$. Si le FP de l'installation n'est pas compris dans cette zone, cette fonction ne peut être utilisée.

En 4 BL / 3 BL / 2BL / 1 BL, le raccordement des TI est uniquement contrôlé.

En 4NBL et 3 NBL l'ensemble du raccordement est contrôlé.

Err 0 = aucune erreur

Err 1 = inversion du raccordement du TC sur la phase 1

Err 2 = inversion du raccordement du TC sur la phase 2

Err 3 = inversion du raccordement du TC sur la phase 3

Err 4 = inversion en tension entre V1 et V2

Err 5 = inversion en tension entre V2 et V3

Err 6 = inversion en tension entre V3 et V1

Pour les Err 1, Err 2 et Err 3, la modification peut se faire automatiquement via le produit **SM102E** ou manuellement en corrigeant le raccordement des courants.

Pour les Err 4, Err 5 et Err 6 la modification doit se faire manuellement en corrigeant le raccordement des tensions.

DE

Beim Test muss das Gerät **SM102E** an allen Anschlüssen mit Strom und Spannung versorgt werden.

Des Weiteren ist für den Test ein Leistungsfaktor der Installation zwischen 0,6 und 1 erforderlich. Wenn der LF der Installation nicht innerhalb dieses Bereiches liegt, kann dieser Test nicht durchgeführt werden.

Bei 4 BL / 3 BL / 2BL / 1 BL wird nur der Anschluss der TI kontrolliert.

Bei 4NBL und 3 NBL wird der gesamte Anschluss kontrolliert.

Err 0 = kein Fehler

Err 1 = Verpolung des Stromwandlers auf Phase 1

Err 2 = Verpolung des Stromwandlers auf Phase 2

Err 3 = Verpolung des Stromwandlers auf Phase 3

Err 4 = Verpolung der Spannung zwischen V1 und V2

Err 5 = Verpolung der Spannung zwischen V2 und V3

Err 6 = Verpolung der Spannung zwischen V3 und V1

Für die Err 1, Err 2 und Err 3 kann die Änderung automatisch über das Produkt **SM102E** oder manuell durch Korrektur der Stromanschlüsse erfolgen.

Für die Err 4, Err 5 und Err 6 muss die Änderung manuell durch Korrektur des Anschlusses an den Spannungspfaden.

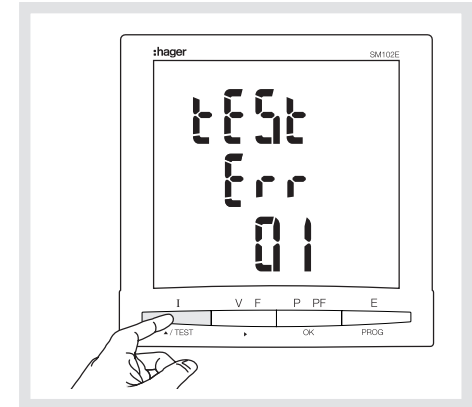

Fonction de test du raccordement - Anschluss Funktionstest - Connection test function -
Collegamento prova funzione - Aansluiting test functie - Conexión prueba función - Ligaçao teste função

GB

During the test, the **SM102E** product must have current and voltage for each of the phases.

In addition to this, the function requires the PF of the installation to be within $0,6 < PF < 1$. If the PF of the installation is not within this range, this function cannot be used.

In 4 BL/3 BL/2BL/1 BL, only the connection of the CTs is controlled.

In 4NBL and 3NBL the connection as a whole is controlled.

Err 0 = no error

Err 1 = CT phase 1 inverted

Err 2 = CT phase 2 inverted

Err 3 = CT phase 3 inverted

Err 4 = V1 and V2 voltages inverted

Err 5 = V2 and V3 voltages inverted

Err 6 = V3 and V1 voltages inverted

For the Err 1, Err 2 and Err 3, the modification can be performed automatically by the **SM102E** product or manually by correcting the current connections.

For the Err 4, Err 5 and Err 6 the modification must be performed manually by correcting the voltage connections.

IT

Al momento del test, il prodotto **SM102E** deve avere corrente e tensione su ciascuna fase.

Inoltre, questa funzione considera l'FP dell'installazione compreso tra $0,6 < FP < 1$. Se l'FP dell'installazione non è compreso in questo intervallo, la funzione non può essere utilizzata.

Il collegamento dei TI è controllato unicamente in 4 BL/3 BL/2BL/1 BL.

L'insieme del collegamento è controllato in 4NBL e 3 NBL.

Err 0 = nessun errore

Err 1 = inversione del raccordo del TC sulla fase 1

Err 2 = inversione del raccordo del TC sulla fase 2

Err 3 = inversione del raccordo del TC sulla fase 3

Err 4 = inversione in tensione tra V1 e V2

Err 5 = inversione in tensione tra V2 e V3

Err 6 = inversione in tensione tra V3 e V1

Per quanto riguarda gli Err 1, Err 2 e Err 3, la modifica si può applicare automaticamente tramite prodotto **SM102E** o manualmente, correggendo il collegamento delle correnti.

Per quanto riguarda gli Err 4, Err 5 e Err 6, la modifica si deve applicare manualmente, correggendo il collegamento delle tensioni.

NL

Tijdens de test moet de product **SM102E** stroom hebben en spanning op beide fasen.

Bovendien is deze functie gebaseerd op een FP van de installatie tussen $0,6 < FP < 1$. Als de FP van de installatie zich niet binnen deze zone bevindt kan deze functie niet worden gebruikt.

In 4 BL / 3 BL / 2BL / 1 BL, wordt alleen de aansluiting van de TI's gecontroleerd.

In 4NBL en 3 NBL wordt het geheel van de aansluiting gecontroleerd.

Err 0 = geen enkele fout

Err 1 = inversie van de aansluiting van de spanningstransformator op fase 1

Err 2 = inversie van de aansluiting van de spanningstransformator op fase 2

Err 3 = inversie van de aansluiting van de spanningstransformator op fase 3

Err 4 = Spanningsinversie tussen V1 en V2

Err 5 = Spanningsinversie tussen V2 en V3

Err 6 = Spanningsinversie tussen V3 en V1

Voor Err 1, Err 2 en Err 3, kan de wijziging automatisch plaatsvinden via de product **SM102E** of handmatig door de aansluiting van de stromen te corrigeren.

Voor de Err 4, Err 5 en Err 6 moet de wijziging handmatig worden doorgevoerd door middel van het corrigeren van de aansluiting van de spanningen.

Fonction de test du raccordement - Anschluss Funktionstest - Connection test function - Collegamento prova funzione - Aansluiting test functie - Conexión prueba función - Ligaçao teste função

ES

Durante la prueba, el producto **SM102E** debe recibir corriente y tensión en cada una de las fases. Además, esta función considera que el factor de potencia (FP) de la instalación se encuentra entre $0,6 < FP < 1$. Si el FP de la instalación no está en ese intervalo, no se podrá utilizar la función.

En los modelos 4 BL / 3 BL / 2BL / 1 BL, únicamente está controlada la conexión de los TI.

En los modelos 4 NBL y 3 NBL están controladas todas las conexiones.

Err 0 = ningún error

Err 1 = inversión de la conexión TC fase 1

Err 2 = inversión de la conexión TC fase 2

Err 3 = inversión de la conexión TC fase 3

Err 4 = inversión intensidad entre V1 e V2

Err 5 = inversión intensidad entre V2 e V3

Err 6 = inversión intensidad entre V3 e V1

En el caso de los modelos Err 1, Err 2 y Err 3, la modificación puede realizarse de forma automática a través del producto **SM102E** o manual por medio de la corrección de la conexión de la corriente.

En el caso de los modelos Err 4, Err5 y Err 6, la modificación puede realizarse de forma manual por medio de la corrección de la conexión de la tensión.

PT

Durante o teste, o produto **SM102E** deve ter corrente e tensão em cada uma das fases.

Além disso, esta função considera que o FP da instalação está compreendido entre $0,6 < FP < 1$. Se o FP da instalação não estiver dentro deste intervalo, esta função não poderá ser utilizada.

Em 4 BL / 3 BL / 2BL / 1 BL, a ligação dos TI só é controlada. Em 4NBL e 3 NBL, é controlado o conjunto da ligação.

Err 0 = nenhum erro

Err 1 = inversão da ligação do TC na fase 1

Err 2 = inversão da ligação do TC na fase 2

Err 3 = inversão da ligação do TC na fase 3

Err 4 = inversão em tensão entre V1 e V2

Err 5 = inversão em tensão entre V2 e V3

Err 6 = inversão em tensão entre V3 e V1

Para os Err 1, Err 2 e Err 3, a modificação pode ser feita automaticamente, através do produto **SM102E**, ou manualmente, corrigindo a ligação das correntes.

Para os Err 4, Err5 e Err 6, a modificação pode ser feita manualmente, corrigindo a ligação das tensões.

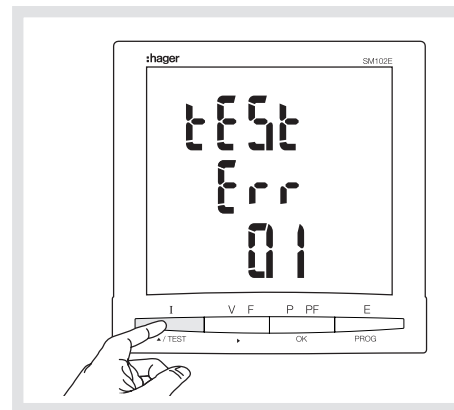

Fonction de test du raccordement - Anschluss Funktionstest - Connection test function -
Collegamento prova funzione - Aansluiting test functie - Conexión prueba función - Ligaçao teste função

Ⓡ Exemple : TEST Err 0

Ⓡ Beispiel: TEST Err 0

Ⓡ Example : TEST Err 0

Ⓡ Esempio: TEST Err 0

Ⓡ Voorbeeld: TEST Err 0

Ⓡ Ejemplo: TEST Err 0

Ⓡ Exemplo: TEST Err 0

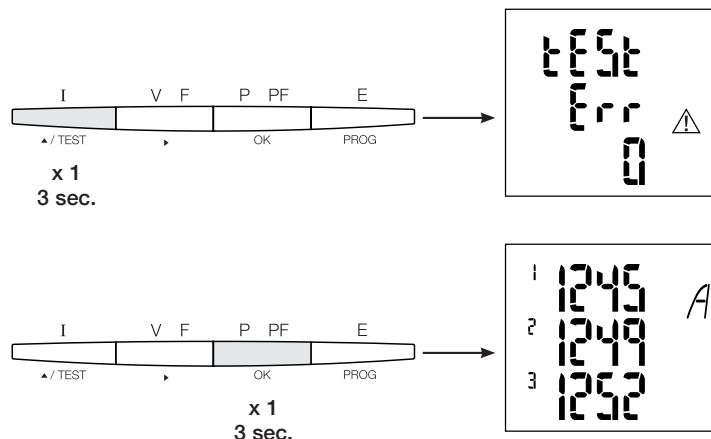

Fonction de test du raccordement - Anschluss Funktionstest - Connection test function -
Collegamento prova funzione - Aansluiting test functie - Conexión prueba función - Ligaçao teste função

FR Exemple : TEST Err 1

DE Beispiel: TEST Err 1

GB Example : TEST Err 1

IT Esempio: TEST Err 1

NL Voorbeeld: TEST Err 1

ES Ejemplo: TEST Err 1

PT Exemplo: TEST Err 1

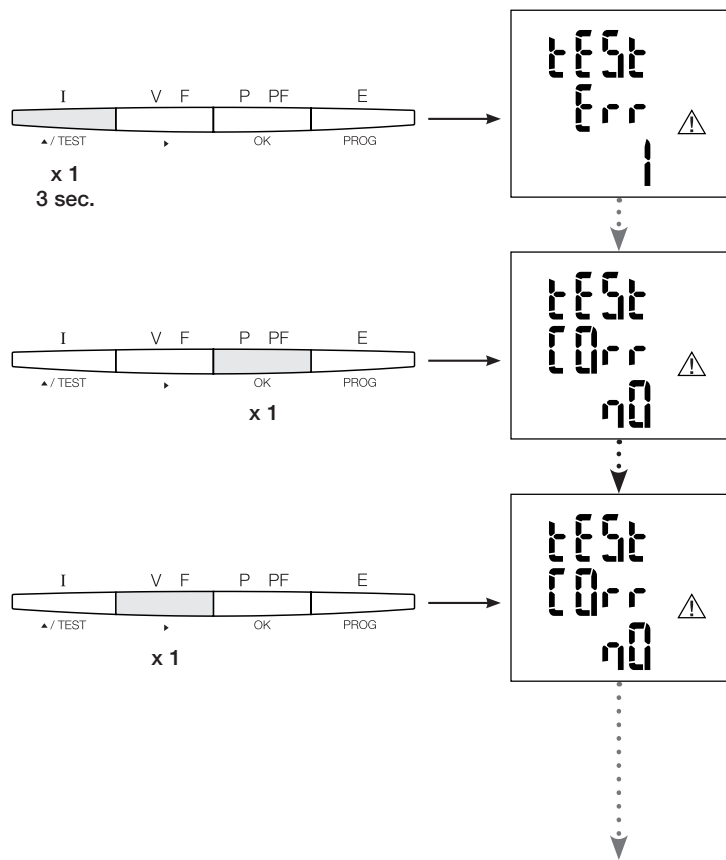

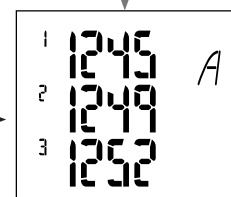
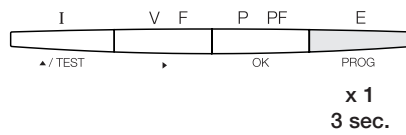
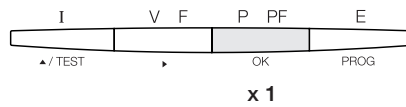
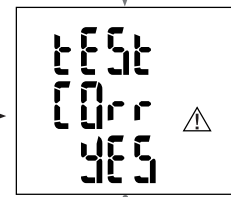
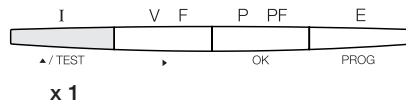

Fonction de test du raccordement - Anschluss Funktionstest - Connection test function - Collegamento prova funzione - Aansluiting test functie - Conexión prueba función - Ligaçao teste função

- FR** 2^{ème} opération de test
Remarque : cette opération ne tient pas compte des modifications effectuées lors du premier test.
- DE** Zweiter Testbetrieb
Hinweis: Bei diesem Betrieb werden die automatisch ausgeführten Änderungen nicht berücksichtigt.
- GB** Second test operation
NB: this operation does not take into account the automatic modifications carried out at the time of the first test.
- IT** 2^a operazione di test
Nota: questa operazione non tiene conto delle modifiche compiute in occasione del primo test.
- NL** 2^o testoperatie
Opmerking: deze operatie houdt geen rekening met de wijzigingen aangebracht tijdens de eerste test.
- ES** Segunda operación de prueba
Nota: operación no tiene en cuenta las modificaciones efectuadas en la primer prueba.
- PT** 2^a operação de teste
Nota: esta operação não leva em conta as modificações efectuadas durante o primeiro teste.

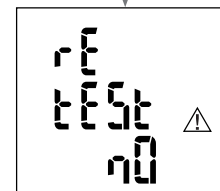
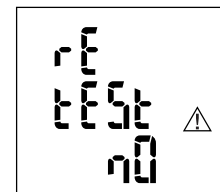
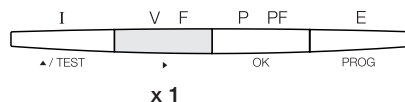
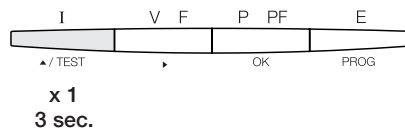

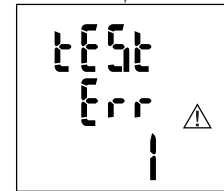
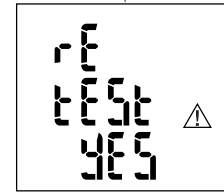
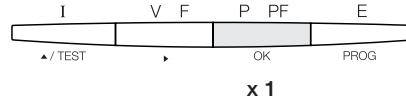
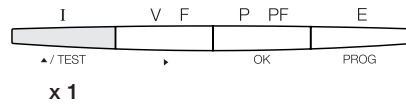

Opération test

Test operation - Testbetrieb - Operazione di test -
 Testoperatie - Segunda operación de prueba - Operação de teste

FR

- **Appareil éteint**
Vérifiez l'alimentation auxiliaire
- **Rétroéclairage éteint**
Vérifiez la configuration du rétroéclairage (p. 32)
- **Tensions = 0**
Vérifiez le raccordement
- **Courants = 0 ou erronés**
Vérifiez le raccordement
Vérifiez la configuration du TC
- **Puissances et facteurs de puissance (PF) erronés**
Lancez la fonction de test du raccordement (p. 44)
- **Phases manquantes sur l'afficheur**
Vérifiez la configuration du réseau (p. 25).

DE

- **Gerät nicht in Betrieb**
Überprüfen Sie die Hilfsspannungsversorgung
- **Hintergrundbeleuchtung erloschen**
Überprüfen Sie die Konfiguration der Hintergrundbeleuchtung (S. 32)
- **Spannungen = 0**
Überprüfen Sie den Anschluß
- **Ströme = 0 oder fehlerhaft**
Überprüfen Sie den Anschluß
Überprüfen Sie die Konfiguration des Stromwandlers
- **Leistungen oder Leistungsfaktor (PF)**
Starten Sie die Anschlußtestfunktion (S. 44)
- **Fehlende Aussenleiter auf der Anzeige**
Überprüfen Sie die Konfiguration des Netzwerks im Setup-Menü (S. 25).

GB

- **Device Switched off**
Check auxiliary supply
- **Backlight switched off**
Check backlight configuration in set up menu (p. 32)
- **Voltage = 0**
Verify the connections
- **Current = 0 or incorrect**
Verify the connections
- **Powers and power-factor (PF)**
Verify the configuration of CT's in set up
- **Phases missing on Display**
Check the Network configuration (in set up menu) (p. 25).

IT

- **Apparecchio spento**
Verificare l'alimentazione ausiliaria
- **Retroilluminato Spento**
Verificare la configurazione di retroilluminato (p. 32)
- **Tensioni = 0**
Verificare il collegamento
- **Correnti = 0 o errati**
Verificare il collegamento
Verificare la configurazione del TA
- **Potenze e fattore di potenza (PF) errati**
Lanciare la funzione di prova del collegamento (p. 45)
- **Fasi mancanti sullo schermo**
Verificare la configurazione della rete (p. 25).

NL

- **Toestel licht niet op**
Controleer de hulpspanning
- **Achtergrondverlichting licht niet op**
Controleer de instellingen van de achtergrondverlichting (p. 32)
- **Spanningen = 0**
Controleer de aansluiting
- **Stromen = 0 of foutief**
Controleer de aansluiting
Controleer de instelling van de TI
- **Vermogens en arbeidsfactor (PF) foutief**
Start de testfunctie van de aansluiting (p. 45)
- **Ontbreken van fasen op het display**
Controleer de instelling van het net (p. 25).

PT

- **Aparelho apagado**
Verificar a alimentação auxiliar
- **Retroiluminação apagado**
Verificar tem configuração do retroiluminação (p. 32)
- **Tensões = 0**
Verificar a conexão
- **Correntes = 0 o errados**
Verificar a conexão
Verificar a configuração do TC
- **Potências e factor de potência (PF) errado**
Lançar a função de teste da conexão (p. 46)
- **Fases em falta sobre display**
Verificar a configuração da rede (p. 25).

ES

- **Aparato apagado**
Verificar la alimentación auxiliar
- **Retroiluminación apagada**
Verificar la configuración del display retroiluminado (p. 32)
- **Tensiones = 0**
Verificar las conexiones
- **Intensidades = 0 o erróneas**
Verificar las conexiones
Verificar la configuración del TC
- **Potencias y factor de potencia (PF) erróneos**
Ejecutar la función test de conexión (p. 46)
- **Ausencia de fases en el display**
Verificar la configuración de la red (p. 25).

BOÎTIER

Dimensions :	96 x 96 x 60 mm - 96 x 96 x 80 avec tous les modules d'options (DIN 43700)
Raccordement :	à partir de borniers débrochables 2,5 mm ² (tensions et autres) et fixes 6 mm ² (courants)
Indice de protection :	Face avant IP52 et boîtier IP30
Poids :	400 g

AFFICHEUR

Type :	LCD avec rétroéclairage
--------	-------------------------

MESURE

Réseau triphasé (3 ou 4 fils), biphasé (2 fils) et monophasé

TENSION (TRMS)

Mesure directe :	Phases/phases : de 50 à 500 V AC - Phase/neutre : de 28 à 289 V AC
Surcharge permanente entre phases :	800 V AC
Période d'actualisation :	1 s

COURANT (TRMS)

A partir du TC avec un :	• Primaire : jusqu'à 9 999 A • Secondaire : 5 A
Courant minimum de mesure	5 mA
Consommation des entrées :	< 0,6 VA
Affichage :	de 0 à 11 kA (1,1 fois la valeur du primaire)
Surcharge permanente :	6 A
Surcharge intermittente :	10 In pendant 1 s
Période d'actualisation :	1 s

PUISSANCES

Totales :	0 à 11 MW/Mvar/MVA
Période d'actualisation :	1 s

FRÉQUENCE

Période d'actualisation :	de 45,0 à 65,0 Hz
Période d'actualisation :	1 s

ALIMENTATION AUXILIAIRE CEI/CE

110 à 400 V AC 50/60 Hz	± 10 %
120 à 350 V DC :	± 20 %
Consommation :	< 10 VA

Caractéristiques techniques - Technische Daten - Technical characteristics -
 Caratteristiche tecniche - Technische eigenschappen - Características técnicas - Características técnicas

PRÉCISION

Énergie active : CEI 62053-22 classe 0,5S

Énergie réactive : CEI 62053-23 classe 2

MARQUAGE CE

Le produit SM102E satisfait aux :

- dispositions de la directive européenne sur la compatibilité électromagnétique (CEM) n° 89/336/CEE du 3 mai 1989, modifiée par la directive n° 92/31/CEE datée du 28 avril 1992 et par la directive n° 93/68/CEE du 22 juillet 1993.
- à la directive basse tension n° 73/23 CEE du 19 février 1973 modifié par la directive n° 93/68/CEE du 22 juillet 1993, modifié par la directive n° 2006/95/CE.

COMPATIBILITÉ ÉLECTROMAGNÉTIQUE

Immunité aux décharges électrostatiques : CEI 61000-4-2 - Niveau III

Immunité aux champs électromagnétiques rayonnés : CEI 61000-4-3 - Niveau III

Immunité aux transitoires rapides en salve : CEI 61000-4-4 - Niveau III

Immunité aux ondes de choc : CEI 61000-4-5 - Niveau III

Immunité aux perturbations induites par les champs radioélectriques : CEI 61000-4-6 - Niveau III

Immunité aux champs magnétiques à la fréquence réseau : CEI 61000-4-8 - Niveau III

Emissions conduites et rayonnées : CISPR11 - Classe A

Immunité aux creux et coupures brèves de tension : CEI 61000-4-11

CLIMAT

Température de fonctionnement : CEI 60068-2-1/CEI 60068-2-2 : -10 °C to +55 °C

Température de stockage : CEI 60068-2-1/CEI 60068-2-2 : -20 °C à +85 °C

Humidité : CEI 60068-2-30 - 95 %

Brouillards salins : CEI 60068-2-52 - 2,5 % NaCl

CARACTÉRISTIQUES MÉCANIQUES

Vibration comprise entre 10 et 50 Hz : CEI 60068-2-6 - 2 g

ISOLATION

Catégorie d'installation : III (480 VAC ph /ph)

Degré de pollution : 2

Tension de choc assignée : CEI 60947-1 - V imp: 4 kV

Face avant : Classe II

Sécurité électrique : CEI 61010-1

CONFORMITÉ CEI 61557-12 EDITION 1 (08/2007)

CARACTÉRISTIQUE DU PMD

Type de caractéristique	Exemples de valeurs caractéristiques possibles	Autres caractéristiques complémentaires
Fonction (éventuelle) d'évaluation de la qualité de l'alimentation	-	-
Classification des PMD	SD	-
Température	K55	-
Humidité + Altitude	-	-
Classe de performance de fonctionnement de la puissance active ou de l'énergie active (si fonction disponible)	0,5	-

CARACTÉRISTIQUES DES FONCTIONS

Symbole des fonctions	Plage de mesure	Classe de performance de fonctionnement, conformément à la CEI 61557-12 en fonction du KI				Autres caractéristiques complémentaires
		1000	100	10	1	
KI		1000	100	10	1	
P	-	0,5	-	-	2	de -90° à 90°
Qa, Qv	-	1	-	-	2	-
Sa, Sv	-	1	-	-	-	-
Ea	0 à 999999999 kW/h	0,5	-	-	-	de 0,02 à 1,2 In avec PF = 0,5L ou 0,8C
Era, Erv	0 à 999999999 kVar/h	2	-	-	-	de 0,1 à 1,2 In avec sin φ = 0,5L ou C
Eapa, Eapv	0 à 999999999 kW/h	0,5	-	-	-	-
f	45 à 65Hz	0,1	-	-	-	-
I	0,5 à 6A	0,2	-	-	-	de 10 à 110% de In
In, Inc	0,5 à 6A	0,5	-	-	-	de 10 à 110% de In
U	50 à 600V phase/phase	0,2	-	-	-	-
PFa, PFv	-	0,5	-	-	-	pour 0,5<PF<1
Pst, Plt	-	-	-	-	-	-
Udip	-	-	-	-	-	-
Uswl	-	-	-	-	-	-
Utr	-	-	-	-	-	-
Uint	-	-	-	-	-	-
Unba	-	-	-	-	-	-
Unb	-	-	-	-	-	-
Uh	50 à 600V phase/phase	1	-	-	-	-
THDu	50 à 600V phase/phase	1	-	-	-	-
THD - Ru	-	-	-	-	-	-
Ih	0,5 à 6A	1	-	-	-	-
THDi	0,5 à 6A	1	-	-	-	-
THD_Ri	-	-	-	-	-	-
Msv	-	-	-	-	-	-

CARACTÉRISTIQUES DES "FONCTIONS D'ÉVALUATION DE LA QUALITÉ DE L'ALIMENTATION"

Symbole des fonctions	Plage de mesure	Classe de performance de fonctionnement, conformément à la CEI 61557-12 en fonction du KI				Autres caractéristiques complémentaires
		1000	100	10	1	
KI		1000	100	10	1	-
f	45 à 65Hz	0,1	-	-	-	-
I	0,5 à 6A	0,2	-	-	-	-
In, Inc	0,5 à 6A	0,5	-	-	-	Uniquement calculé
U	50 à 600V (phase/phase)	0,2	-	-	-	-
Pst, Plt	-	-	-	-	-	-
Udip	-	-	-	-	-	-
Uswl	-	-	-	-	-	-
Uint	-	-	-	-	-	-
Unba	-	-	-	-	-	-
Unb	-	-	-	-	-	-
Uh	-	-	-	-	-	-
Ih	-	-	-	-	-	-
Msv	-	-	-	-	-	-

DE

GEHÄUSE	
Abmessungen:	96x96x60 oder 80 mit sämtlichen Modulen (DIN 43700)
Anschluß:	über herausziehbare Klemmleisten 2,5 mm ² (Spannungen usw.) und feste Klemmleisten 6 mm ² (für Ströme).
Schutzgrad:	Frontseite IP52 und Gehäuse IP30
Gewicht:	400 gr
ANZEIGE	
Typ:	LCD-Anzeige mit Hintergrundbeleuchtung
MESSUNGEN	
Netz: dreiphasig (3 oder 4 Leiter), zweiphasig (2 Leiter) und einphasig	
SPANNUNGSWERTE (TRMS)	
Direkt:	Aussenleiter/Aussenleiter: von 50 bis 500 V AC Aussenleiter/Neutralleiter: von 28 bis 289 V AC
Anhaltende Überlast:	800 V AC
Aktualisierung der Anzeige:	1 Sekunde
STROMWERTE (TRMS)	
über stromwandler:	• Primär: bis 9 999 A • Sekundär: 5 A
Minimaler Messstrom	5 mA
Eigenverbrauch Eingänge:	< 0,6 VA
Anzeige:	von 0 bis 11 kA (1,1 x Primärwert)
ständige Überlast:	6 A
Kurzzeitige Überlast:	10 In während 1 Sekunde
Aktualisierung der Messung:	1 Sekunde
LEISTUNGSWERTE	
Insgesamt:	0 bis 11 MW/Mvar/MVA
Aktualisierung der Messung:	1 Sekunde
FREQUENZWERTE	
von 45,0 bis 65,0 Hz	
Aktualisierung der Messung:	1 Sekunde
HILFSSPANNUNG IEC/CE	
110 bis 400 V AC bei 50/60 Hz	± 10 %
120 bis 350 V DC :	± 20 %
Eigenverbrauch:	< 10 VA

GENAUIGKEIT

Genauigkeit bei der Wirkenergie: IEC 62053-22 Klasse 0,5S

Genauigkeit bei der Blindenergie: IEC 62053-23 Klasse 2

CE-KENNZEICHNUNG

The SM102E product complies with:

- The requirements of the European directive on electromagnetic compatibility (EMC) no. 89/336/CEE dated 3 May 1989, modified by directive no. 92/31/CEE dated 28 April 1992 and by directive no. 93/68/CEE dated 22 July 1993.
- Low voltage directive no. 73/23/CEE dated 19 February 1973, modified by directive no. 93/68/CEE dated 22 July 1993, modified by directive no. 2006/95/CE.

ELEKTROMAGNETISCHE VERTRÄGLICHKEIT

Immunity to electrostatic discharges: IEC 61000-4-2 - Level III

Immunity to radiated radio-frequency fields: IEC 61000-4-3 - Level III

Immunity to electrical fast transients/bursts: IEC 61000-4-4 - Level III

Immunity to surge immunity: IEC 61000-4-5 - Level III

Immunity to conducted disturbances: IEC 61000-4-6 - Level III

Immunity to power frequency magnetic fields: IEC 61000-4-8 - Level III

Conducted and radiated emissions: CISPR11 - Class A

Immunity to voltage dips and short interruptions: IEC 61000-4-11

KLIMA

Operating-temperature range: IEC 60068-2-1/IEC 60068-2-2: -10 °C to +55 °C

Storage temperature range: IEC 60068-2-1/IEC 60068-2-2: -20 °C to +85 °C

Humidity: IEC 60068-2-30 - 95 %

Salt mist: IEC 60068-2-52 - 2,5 % NaCl

SCHWINGUNGEN

Vibration from 10 to 50 Hz: IEC 60068-2-6 - 2 g

ISOLATION

Installation category: III (480 VAC ph /ph)

Degree of pollution: 2

Rated impulse withstand voltage: IEC 60947-1 - V imp: 4 kV

Front face: Class II

Electric safety: IEC 61010-1

IEC 61557-12 KONFORMITÄT EDITION 1 (08/2007)

MERKMALE DES PMD

Merkmale	Beispiele möglicher Kennwerte	Zusätzliche Merkmale
(Eventuelle) Funktion zur Ermittlung der Stromversorgungsqualität	-	-
Klassifizierung des PMD	SD	-
Temperatur	K55	-
Feuchte + Höhe	-	-
Betriebsleistungsklasse der Wirkleistung oder der Wirkenergie (wenn Funktion verfügbar)	0,5	-

FUNKTIONSMERKMALE

Funktions- symbole	Messbereich	Betriebsleistungs-kategorie, gemäß der Norm IEC 61557-12 entsprechend Ki				Zusätzliche Merkmale
		1000	100	10	1	
KI		1000	100	10	1	
P	-	0,5	-	-	2	von -90° bis 90°
Qa, Qv	-	1	-	-	2	-
Sa, Sv	-	1	-	-	-	-
Ea	0 bis 999999999 kW/h	0,5	-	-	-	von 0,02 bis 1,2 In mit PF = 0,5L oder 0,8C
Era, Erv	0 bis 999999999 kVar/h	2	-	-	-	von 0,1 bis 1,2 In mit sin φ = 0,5L oder C
Eapa, Eapv	0 bis 999999999 kW/h	0,5	-	-	-	-
f	45 bis 65Hz	0,1	-	-	-	-
I	0,5 bis 6A	0,2	-	-	-	von 10 bis 110% von In
In, Inc	0,5 bis 6A	0,5	-	-	-	von 10 bis 110% von In
U	50 bis 600V (phase/phase)	0,2	-	-	-	-
PFa, PFv	-	0,5	-	-	-	für 0,5<PF<1
Pst, Plt	-	-	-	-	-	-
Udip	-	-	-	-	-	-
Uswl	-	-	-	-	-	-
Utr	-	-	-	-	-	-
Uint	-	-	-	-	-	-
Unba	-	-	-	-	-	-
Unb	-	-	-	-	-	-
Uh	50 bis 600V (phase/phase)	1	-	-	-	-
THDu	50 bis 600V (phase/phase)	1	-	-	-	-
THD - Ru	-	-	-	-	-	-
Ih	0,5 bis 6A	1	-	-	-	-
THDi	0,5 bis 6A	1	-	-	-	-
THD_Ri	-	-	-	-	-	-
Msv	-	-	-	-	-	-

MERKMALE DER "FUNKTIONEN ZUR ERMITTLUNG DER STROMVERSORGUNGSQUALITÄT"

Funktions- symbole	Messbereich	Betriebsleistungs-kategorie, gemäß der Norm IEC 61557-12 entsprechend Ki				Zusätzliche Merkmale
		1000	100	10	1	
KI		1000	100	10	1	-
f	45 bis 65Hz	0,1	-	-	-	-
I	0,5 bis 6A	0,2	-	-	-	-
In, Inc	0,5 bis 6A	0,5	-	-	-	-
U	50 bis 600V (phase/phase)	0,2	-	-	-	-
Pst, Plt	-	-	-	-	-	-
Udip	-	-	-	-	-	-
Uswl	-	-	-	-	-	-
Uint	-	-	-	-	-	-
Unba	-	-	-	-	-	-
Unb	-	-	-	-	-	-
Uh	-	-	-	-	-	-
Ih	-	-	-	-	-	-
Msv	-	-	-	-	-	-

CASE	
Dimensions:	96 x 96 x 60 mm or 96 x 96 x 80 mm with all optional modules (DIN 43700)
Connection:	via 2.5 mm ² disconnectable terminals (voltage and others) and 6 mm ² fixed terminals (current)
IP index:	IP52 (front panel) and IP30 (case)
Weight:	400 gr.
DISPLAY	
Type:	backlit LCD display
MEASUREMENTS	
Three-phase (3 or 4 wires), two-phase (2 wire) and single-phase networks	
VOLTAGE (TRMS)	
Direct measurement:	from 50 to 500 V AC (phase/phase) from 28 to 289 V AC (phase/neutral)
Permanent overload:	800 V AC
Update period:	1 second
CURRENT (TRMS)	
Via CT with:	• Primary: up to 9 999 A • Secondary: 5 A
Minimum measuring current	5 mA
Input consumption:	< 0.6 VA
Display:	from 0 to 11 kA (1.1 times the primary value)
permanent overload:	6 A
intermittent overload:	10 In / 1 second
Update period:	1 second
POWER	
Total:	0 to 11 MW/Mvar/MVA
Update period:	1 second
FREQUENCY	
from 45,0 to 65,0 Hz	
Update period:	1 second
AUXILIARY SUPPLY IEC/CE	
110 to 400 V AC 50/60 Hz	± 10 %
120 to 350 V DC	± 20 %
Consumption:	< 10 VA

ACCURACY

Accuracy on active energy: IEC 62053-22 class 0.5S

Accuracy on reactive energy: IEC 62053-23 class 2

CE MARKING

The SM102E product complies with:

- The requirements of the European directive on electromagnetic compatibility (EMC) no. 89/336/CEE dated 3 May 1989, modified by directive no. 92/31/CEE dated 28 April 1992 and by directive no. 93/68/CEE dated 22 July 1993.
- Low voltage directive no. 73/23/CEE dated 19 February 1973, modified by directive no. 93/68/CEE dated 22 July 1993, modified by directive n° 2006/95/CE.

ELECTROMAGNETIC COMPATIBILITY

Immunity to electrostatic discharges: IEC 61000-4-2 - Level III

Immunity to radiated radio-frequency fields: IEC 61000-4-3 - Level III

Immunity to electrical fast transients/bursts: IEC 61000-4-4 - Level III

Immunity to surge immunity: IEC 61000-4-5 - Level III

Immunity to conducted disturbances: IEC 61000-4-6 - Level III

Immunity to power frequency magnetic fields: IEC 61000-4-8 - Level III

Conducted and radiated emissions: CISPR11 - Class A

Immunity to voltage dips and short interruptions: IEC 61000-4-11

CLIMATE

Operating-temperature range: IEC 60068-2-1/IEC 60068-2-2: -10 °C to +55 °C

Storage temperature range: IEC 60068-2-1/IEC 60068-2-2: -20 °C to +85 °C

Humidity: IEC 60068-2-30 - 95 %

Saling fog: IEC 60068-2-52 - 2,5 % NaCl

MECHANICAL CHARACTERISTICS

Vibration from 10 to 50 Hz: IEC 60068-2-6 - 2 g

INSULATION

Installation category: III (480 VAC ph /ph)

Degree of pollution: 2

Rated impulse withstand voltage: IEC 60947-1 - V imp: 4 kV

Front face: Class II

Electric safety: IEC 61010-1

CONFORMITY IEC 61557-12 EDITION 1 (08/2007)

PMD SPECIFICATIONS

Type of specification	Examples of possible specification values	Other additional specifications
Supply quality evaluation function (optional)	-	-
PMD classification	SD	-
Setpoint	K55	-
Humidity + Altitude	-	-
Operating performance class for active power or active energy (if function available)	0,5	-

FUNCTION SPECIFICATIONS

Symbols for functions	Measurement range	Operating performance class, according to IEC 61557-12 according to KI				Other additional specifications
		1000	100	10	1	
KI		1000	100	10	1	
P	-	0,5	-	-	2	from -90° to 90°
Qa, Qv	-	1	-	-	2	-
Sa, Sv	-	1	-	-	-	-
Ea	0 to 99999999 kW/h	0,5	-	-	-	from 0,02 to 1,2 In with PF = 0,5L or 0,8C
Era, Erv	0 to 99999999 kVar/h	2	-	-	-	from 0,1 to 1,2 In with sin φ = 0,5L or C
Eapa, Eapv	0 to 99999999 kW/h	0,5	-	-	-	-
f	45 to 65Hz	0,1	-	-	-	-
I	0,5 to 6A	0,2	-	-	-	from 10 to 110% to In
In, Inc	0,5 to 6A	0,5	-	-	-	from 10 to 110% to In
U	50 to 600V (phase/phase)	0,2	-	-	-	-
PFa, PFv	-	0,5	-	-	-	for 0,5<PF<1
Pst, Plt	-	-	-	-	-	-
Udip	-	-	-	-	-	-
Uswl	-	-	-	-	-	-
Utr	-	-	-	-	-	-
Uint	-	-	-	-	-	-
Unba	-	-	-	-	-	-
Unb	-	-	-	-	-	-
Uh	50 to 600V (phase/phase)	1	-	-	-	-
THDu	50 to 600V (phase/phase)	1	-	-	-	-
THD - Ru	-	-	-	-	-	-
Ih	0,5 to 6A	1	-	-	-	-
THDi	0,5 to 6A	1	-	-	-	-
THD_Ri	-	-	-	-	-	-
Msv	-	-	-	-	-	-



SPECIFICATION FOR “SUPPLY QUALITY EVALUATION FUNCTIONS”

Symbols for functions	Measurement range	Operating performance class, according to IEC 61557-12 according to KI				Other additional specifications
		1000	100	10	1	
KI		1000	100	10	1	-
f	45 to 65Hz	0,1	-	-	-	-
I	0,5 to 6A	0,2	-	-	-	-
In, Inc	0,5 to 6A	0,5	-	-	-	-
U	50 to 600V (phase/phase)	0,2	-	-	-	-
Pst, Plt	-	-	-	-	-	-
Udip	-	-	-	-	-	-
Uswl	-	-	-	-	-	-
Uint	-	-	-	-	-	-
Unba	-	-	-	-	-	-
Unb	-	-	-	-	-	-
Uh	-	-	-	-	-	-
Ih	-	-	-	-	-	-
Msv	-	-	-	-	-	-



SCATOLA

Dimensioni	96x96x60 - 96x96x80 con tutti i moduli opzionali (DIN 43700)
Collegamenti	2,5 mm ² per le morsettiere staccabili (tensione e moduli) e da 6 mm ² per quelle fisse (correnti)
Grado di protezione:	Frontale IP52 e Scatola IP30
Peso:	400g

DISPLAY

Tipo:	LCD retroilluminato
-------	---------------------

MISURE

Rete trifase (3 o 4 fili), bifase (2 fili) e monofase

TENSIONE (TRMS)

Misura diretta	Fase/fase: da 50 a 500 V AC - Fase/neutro: da 28 a 289 V AC
Sovraccarico permanente (fase/fase)	800 V AC
Periodo di attualizzazione	1 secondo

CORRENTE (TRMS)

Ingresso da TA con:	• Primario: fino a 9 999 A • Secondario: 5 A
Corrente minima di misura	5 mA
Consumo delle entrate	< 0,6 VA
Visualizzazione	da 0 a 11 kA (1,1 volte il valore del primario)
Sovraccarico permanente	6 A
Sovraccarico intermittente	10 In per 1 secondo
Periodo di attualizzazione	1 s

POTENZE

Totale	da 0 a 11 MW/Mvar/MVA
Periodo di attualizzazione	1 s

FREQUENZA

Periodo di attualizzazione	da 45,0 a 65,0 Hz
	1 s

ALIMENTAZIONE AUSILIARIA IEC/CE

da 110 a 400 V AC 50/60 Hz	± 10 %
da 120 a 350 V DC	± 20 %
Consumo	< 10 VA

PRECISIONE

Precisione sull'energia attiva: IEC 62053-22 classe 0,5S

Precisione sull'energia reattiva: IEC 62053-23 classe 2

MARCATURA CE

The SM102E product complies with :

- The requirements of the European directive on electromagnetic compatibility (EMC) no. 89/336/CEE dated 3 May 1989, modified by directive no. 92/31/CEE dated 28 April 1992 and by directive no. 93/68/CEE dated 22 July 1993.
- Low voltage directive no. 73/23/CEE dated 19 February 1973, modified by directive no. 93/68/CEE dated 22 July 1993, modified by directive no. 2006/95/CE.

COMPATIBILITÀ ELETTROMAGNETICA

Immunity to electrostatic discharges: IEC 61000-4-2 - Level III

Immunity to radiated radio-frequency fields: IEC 61000-4-3 - Level III

Immunity to electrical fast transients/bursts: IEC 61000-4-4 - Level III

Immunity to surge immunity: IEC 61000-4-5 - Level III

Immunity to conducted disturbances: IEC 61000-4-6 - Level III

Immunity to power frequency magnetic fields: IEC 61000-4-8 - Level III

Conducted and radiated emissions: CISPR11 - Class A

Immunity to voltage dips and short interruptions: IEC 61000-4-11

CLIMA

Operating-temperature range: IEC 60068-2-1/IEC 60068-2-2: -10 °C to +55 °C

Storage temperature range: IEC 60068-2-1/IEC 60068-2-2: -20 °C to +85 °C

Humidity: IEC 60068-2-30 - 95 %

Salt mist: IEC 60068-2-52 - 2,5 % NaCl

CARATTERISTICHE MECCANICHE

Vibration from 10 to 50 Hz : IEC 60068-2-6 - 2 g

ISOLAMENTO

Installation category: III (480 VAC ph /ph)

Degree of pollution: 2

Rated impulse withstand voltage: IEC 60947-1 - V imp: 4 kV

Front face: Class II

Electric safety: IEC 61010-1



CONFORMITÀ IEC 61557-12 EDITION 1 (08/2007)

CARATTERISTICHE DEL PMD

Tipo di caratteristica	Esempi di valori caratteristiche possibili	Altre caratteristiche complementari
Funzione (eventuale) di valutazione della qualità dell'alimentazione	-	-
Classificazione dei PMD	SD	-
Temperatura	K55	-
Umidità + Altitudine	-	-
Classe di prestazione di funzionamento della potenza attiva o dell'energia attiva (se la funzione è disponibile)	0,5	-

CARATTERISTICHE DELLE FUNZIONI

Simbolo del funzioni	Intervallo di misura	Classe di prestazione di funzionamento, secondo la norma IEC 61557-12				Altre caratteristiche complementari
		1000	100	10	1	
KI						
P	-	0,5	-	-	2	da -90° a 90°
Qa, Qv	-	1	-	-	2	-
Sa, Sv	-	1	-	-	-	-
Ea	da 0 a 999999999 kW/h	0,5	-	-	-	da 0,02 a 1,2 In con PF = 0,5L o 0,8C
Era, Erv	da 0 a 999999999 kVar/h	2	-	-	-	da 0,1 a 1,2 In con sin φ = 0,5L o C
Eapa, Eapv	da 0 a 999999999 kW/h	0,5	-	-	-	-
f	da 45 a 65Hz	0,1	-	-	-	-
I	da 0,5 a 6A	0,2	-	-	-	da 10 a 110% di In
In, Inc	da 0,5 a 6A	0,5	-	-	-	da 10 a 110% di In
U	da 50 a 600V (fase/fase)	0,2	-	-	-	-
PFa, PFv	-	0,5	-	-	-	per 0,5<PF<1
Pst, Plt	-	-	-	-	-	-
Udip	-	-	-	-	-	-
Uswl	-	-	-	-	-	-
Utr	-	-	-	-	-	-
Uint	-	-	-	-	-	-
Unba	-	-	-	-	-	-
Unb	-	-	-	-	-	-
Uh	da 50 a 600V (fase/fase)	1	-	-	-	-
THDu	da 50 a 600V (fase/fase)	1	-	-	-	-
THD - Ru	-	-	-	-	-	-
Ih	da 0,5 a 6A	1	-	-	-	-
THDi	da 0,5 a 6A	1	-	-	-	-
THD_Ri	-	-	-	-	-	-
Msv	-	-	-	-	-	-



CARATTERISTICHE DELLE “FUNZIONI DI VALUTAZIONE DELLA QUALITÀ DELL'ALIMENTAZIONE”

Simbolo delle funzioni	Intervallo di misura	Classe di prestazione di funzionamento, secondo la norma IEC 61557-12				Altre caratteristiche complementari
		1000	100	10	1	
KI		1000	100	10	1	-
f	da 45 a 65Hz	0,1	-	-	-	-
I	da 0,5 a 6A	0,2	-	-	-	-
In, Inc	da 0,5 a 6A	0,5	-	-	-	-
U	da 50 a 600V (phase/phase)	0,2	-	-	-	-
Pst, Plt	-	-	-	-	-	-
Udip	-	-	-	-	-	-
Uswl	-	-	-	-	-	-
Uint	-	-	-	-	-	-
Unba	-	-	-	-	-	-
Unb	-	-	-	-	-	-
Uh	-	-	-	-	-	-
Ih	-	-	-	-	-	-
Msv	-	-	-	-	-	-



BEHUIZING

Afmetingen:	96 x 96 x 60 mm of 96 x 96 x 80 met alle optionele modules (DIN 43700)
Aansluiting:	via afneembare klemmenstroken 2,5 mm ² (spanningen en andere) en vaste klemmenstroken 6 mm ² (stromen)
Beschermingsindex:	Voorzijde IP52 en kast IP30
Gewicht:	400 gr

DISPLAY

Type:	LCD met backlight
-------	-------------------

METINGEN

Driefasennet (3 of 4 draden), tweefasennet (2 draden) en enkfasesnet

SPANNING (TRMS)

Directe meting:	Fase/fase:van 50 tot 500 V AC - Fase/nul:van 28 tot 289 V AC
Permanente overbelasting:	800 V AC
Updateperiode:	1 seconde

STROOM (TRMS)

Vanaf de stroomtransformator met een:	• Primaire:tot 9 999 A • Secundaire:5 A
Minimale meetstroom	5 mA
Verbruik van de ingangen:	< 0,6 VA
Weergave:	van 0 tot 11 kA (1,1 maal de waarde van de primaire)
Permanente overbelasting:	6 A
Intermittente overbelasting:	10 In gedurende 1 seconde
Updateperiode:	1 seconde

VERMOGENS

Totalen:	0 tot 11 MW/Mvar/MVA
Updateperiode:	1 seconde

FREQUENTIE:

Updateperiode:	1 seconde
----------------	-----------

HULPVOEDING IEC/CE

110 tot 400 V AC: bij 50/60 Hz	± 10 %
120 tot 350 V DC:	± 20 %
Verbruik:	< 10 VA

NAUWKEURIGHEID

Precisie op de actieve energie:	IEC 62053-22 klasse 0,5S
Precisie op de reactieve energie:	IEC 62053-23 klasse 2

EG-MARKERING

The SM102E product complies with :

- The requirements of the European directive on electromagnetic compatibility (EMC) no. 89/336/CEE dated 3 May 1989, modified by directive no. 92/31/CEE dated 28 April 1992 and by directive no. 93/68/CEE dated 22 July 1993.
- Low voltage directive no. 73/23/CEE dated 19 February 1973, modified by directive no. 93/68/CEE dated 22 July 1993, modified by directive no. 2006/95/CE.

ELEKTROMAGNETISCHE VERENIGBAARHEID

Immunity to electrostatic discharges:	IEC 61000-4-2 - Level III
Immunity to radiated radio-frequency fields:	IEC 61000-4-3 - Level III
Immunity to electrical fast transients/bursts:	IEC 61000-4-4 - Level III
Immunity to impulse waves:	IEC 61000-4-5 - Level III
Immunity to conducted disturbances:	IEC 61000-4-6 - Level III
Immunity to power frequency magnetic fields:	IEC 61000-4-8 - Level III
Conducted and radiated emissions:	CISPR11 - Class A
Immunity to voltage dips and short interruptions:	IEC 61000-4-11

KLIMAAT

Operating-temperature range:	IEC 60068-2-1/IEC 60068-2-2: -10 °C to +55 °C
Storage temperature range:	IEC 60068-2-1/IEC 60068-2-2: -20 °C to +85 °C
Humidity:	IEC 60068-2-30 - 95 %
Salt mist:	IEC 60068-2-52 - 2,5 % NaCl

MACHINALE EIGENSCHAPPEN

Vibration from 10 to 50 Hz :	IEC 60068-2-6 - 2 g
------------------------------	---------------------

ISOLATIE

Installation category:	III (480 VAC ph /ph)
Degree of pollution:	2
Rated impulse withstand voltage:	IEC 60947-1 - V imp: 4 kV
Front face:	Class II
Electric safety:	IEC 61010-1



CONFORMITEIT IEC 61557-12 EDITION 1 (08/2007)

MERKMALE DES PMD

Type van het kenmerk	Voorbeelden van mogelijke kenmerkende waarden	Andere aanvullende kenmerken
Eventuele functie voor de beoordeling van de kwaliteit van de voeding	-	-
Classificatie van de PMD	SD	-
Temperatuur	K55	-
Vochtigheid + Hoogte	-	-
Prestatieklasse van de werking van het actieve vermogen of van de actieve energie (indien functie beschikbaar)	0,5	-

KENMERKEN VAN DE FUNCTIES

Symbool van de functies	Meetbereik	Prestatieklasse van de werking aan IEC 61557-12				Andere aanvullende kenmerken
		1000	100	10	1	
KI		1000	100	10	1	
P	-	0,5	-	-	2	van -90° tot 90°
Qa, Qv	-	1	-	-	2	-
Sa, Sv	-	1	-	-	-	-
Ea	0 tot 999999999 kW/h	0,5	-	-	-	van 0,02 tot 1,2 In met PF = 0,5L of 0,8C
Era, Erv	0 tot 999999999 kVar/h	2	-	-	-	van 0,1 tot 1,2 In met sin φ = 0,5L of C
Eapa, Eapv	0 tot 999999999 kW/h	0,5	-	-	-	-
f	45 tot 65Hz	0,1	-	-	-	-
I	0,5 tot 6A	0,2	-	-	-	van 10 tot 110% van In
In, Inc	0,5 tot 6A	0,5	-	-	-	van 10 tot 110% van In
U	50 tot 600V (fase/fase)	0,2	-	-	-	-
PFa, PFv	-	0,5	-	-	-	voor 0,5 < PF < 1
Pst, Pit	-	-	-	-	-	-
Udip	-	-	-	-	-	-
Uswl	-	-	-	-	-	-
Utr	-	-	-	-	-	-
Uint	-	-	-	-	-	-
Unba	-	-	-	-	-	-
Unb	-	-	-	-	-	-
Uh	50 tot 600V (fase/fase)	1	-	-	-	-
THDu	50 tot 600V (fase/fase)	1	-	-	-	-
THD - Ru	-	-	-	-	-	-
Ih	0,5 tot 6A	1	-	-	-	-
THDi	0,5 tot 6A	1	-	-	-	-
THD_Ri	-	-	-	-	-	-
Msv	-	-	-	-	-	-



KENMERKEN VAN DE “FUNCTIES VOOR DE BEOORDELING VAN DE KWALITEIT VAN DE VOEDING”

Symbool van de functies	Meetbereik	Prestatieklasse van de werking aan IEC 61557-12				Andere aanvullende kenmerken
		1000	100	10	1	
KI		1000	100	10	1	-
f	45 tot 65Hz	0,1	-	-	-	-
I	0,5 tot 6A	0,2	-	-	-	-
In, Inc	0,5 tot 6A	0,5	-	-	-	-
U	50 tot 600V (fase/fase)	0,2	-	-	-	-
Pst, Plt	-	-	-	-	-	-
Udip	-	-	-	-	-	-
Uswl	-	-	-	-	-	-
Uint	-	-	-	-	-	-
Unba	-	-	-	-	-	-
Unb	-	-	-	-	-	-
Uh	-	-	-	-	-	-
Ih	-	-	-	-	-	-
Msv	-	-	-	-	-	-

CAJA	
Dimensiones:	96x96x60 o 80 con todos los módulos de opciones (DIN 43700)
Conexión	a partir de las cajas de bornes móviles 2,5 mm ² (tensiones y otros) y fijas 6 mm ² (intensidades)
Indice de protección:	Cara frontal IP52 y caja IP30
Peso:	400 gr
VISUALIZADOR	
Type:	LCD con retroiluminación
MEDIDAS	
Red trifásica (3 o 4 hilos), bifásica (2 hilos) y monofásica	
TENSIÓN (TRMS)	
Medida directa:	Fase/fase de 50 a 500 V AC - Fase/neutro de 28 a 289 V AC
Sobrecarga permanente:	800 V AC
Periodo de actualización:	1 segundo
INTENSIDAD (TRMS)	
A partir de transformador de intensidad con un:	• Primario hasta 9 999 A • Secundario 5 A
Corriente mínima de medida	5 mA
Consumo des entradas:	< 0,6 VA
Visualización	de 0 a 11 kA (1,1 veces el valor del primario)
Sobrecarga permanente:	6 A
Sobrecarga intermitente:	10 In durante 1 segundo
Periodo de actualización:	1 segundo
POTENCIAS	
Totales:	0 a 11 MW/Mvar/MVA
Periodo de actualización:	1 segundo
FRECUENCIA	
Periodo de actualización:	de 45,0 à 65,0 Hz
Periodo de actualización:	1 segundo
ALIMENTACIÓN AUXILIAR IEC/CE	
110 a 400 V AC	en 50/60 Hz ± 10 %
120 a 350 V DC	± 20 %
Consumo	< 10 VA

PRECISIÓN

Precisión en la energía activa : IEC 62053-22 clase 0,5S

Precisión en la energía reactiva : IEC 62053-23 clase 2

MARCADO CE

The SM102E product complies with :

- The requirements of the European directive on electromagnetic compatibility (EMC) no. 89/336/CEE dated 3 May 1989, modified by directive no. 92/31/CEE dated 28 April 1992 and by directive no. 93/68/CEE dated 22 July 1993.
- Low voltage directive no. 73/23/CEE dated 19 February 1973, modified by directive no. 93/68/CEE dated 22 July 1993, modified by directive no. 2006/95/CE.

COMPATIBILIDAD ELECTROMAGNÉTICA

Immunity to electrostatic discharges: IEC 61000-4-2 - Level III

Immunity to radiated radio-frequency fields: IEC 61000-4-3 - Level III

Immunity to electrical fast transients/bursts: IEC 61000-4-4 - Level III

Immunity to surge immunity: IEC 61000-4-5 - Level III

Immunity to conducted disturbances: IEC 61000-4-6 - Level III

Immunity to power frequency magnetic fields: IEC 61000-4-8 - Level III

Conducted and radiated emissions: CISPR11 - Class A

Immunity to voltage dips and short interruptions: IEC 61000-4-11

CLIMAT

Operating-temperature range: IEC 60068-2-1/IEC 60068-2-2: -10 °C to +55 °C

Storage temperature range: IEC 60068-2-1/IEC 60068-2-2: -20 °C to +85 °C

Humidity: IEC 60068-2-30 - 95 %

Salt mist: IEC 60068-2-52 - 2,5 % NaCl

CARACTERÍSTICAS MECÁNICAS

Vibration from 10 to 50 Hz : IEC 60068-2-6 - 2 g

AISLAMIENTO

Installation category: III (480 VAC ph /ph)

Degree of pollution: 2

Rated impulse withstand voltage: IEC 60947-1 - V imp: 4 kV

Front face: Class II

Electric safety: IEC 61010-1

CONFORMIDAD CON IEC 61557-12 EDITION 1 (08/2007)

CARACTERÍSTICAS DEL PMD

Tipo de característica	Ejemplo de valores característicos posibles	Otras características
Función (eventual) de evaluación de la calidad de la alimentación	-	-
Clasificación de los PMD	SD	-
Temperatura	K55	-
Humedad + Altitud	-	-
Clase de rendimiento de funcionamiento de la potencia activa o de la energía activa (si la función se encuentra disponible)	0,5	-

CARACTERÍSTICAS DE LAS FUNCIONES

Símbolo de las funciones	Rango de medición	Clase de rendimiento de funcionamiento, según la norma IEC 61557-12				Otras características complementarias
		1000	100	10	1	
KI		1000	100	10	1	
P	-	0,5	-	-	2	de -90° a 90°
Qa, Qv	-	1	-	-	2	-
Sa, Sv	-	1	-	-	-	-
Ea	de 0 a 999999999 kW/h	0,5	-	-	-	de 0,02 a 1,2 In con PF = 0,5L o 0,8C
Era, Erv	de 0 a 999999999 kVar/h	2	-	-	-	de 0,1 a 1,2 In con sin φ = 0,5L o C
Eapa, Eapv	de 0 a 999999999 kW/h	0,5	-	-	-	-
f	de 45 a 65Hz	0,1	-	-	-	-
I	de 0,5 a 6A	0,2	-	-	-	de 10 a 110% de In
In, Inc	de 0,5 a 6A	0,5	-	-	-	de 10 a 110% de In
U	de 50 a 600V (fase/fase)	0,2	-	-	-	-
PFa, PFv	-	0,5	-	-	-	para 0,5<PF<1
Pst, Plt	-	-	-	-	-	-
Udip	-	-	-	-	-	-
Uswl	-	-	-	-	-	-
Utr	-	-	-	-	-	-
Uint	-	-	-	-	-	-
Unba	-	-	-	-	-	-
Unb	-	-	-	-	-	-
Uh	de 50 a 600V (fase/fase)	1	-	-	-	-
THDu	de 50 a 600V (fase/fase)	1	-	-	-	-
THD - Ru	-	-	-	-	-	-
Ih	de 0,5 a 6A	1	-	-	-	-
THDi	de 0,5 a 6A	1	-	-	-	-
THD_Ri	-	-	-	-	-	-
Msv	-	-	-	-	-	-

CARACTERÍSTICAS DE LAS "FUNCIONES DE EVALUACIÓN DE LA CALIDAD DE LA ALIMENTACIÓN"

Símbolo de las funciones	Rango de medición	Clase de rendimiento de funcionamiento, según la norma IEC 61557-12				Otras características complementarias
		1000	100	10	1	
KI		1000	100	10	1	-
f	de 45 a 65Hz	0,1	-	-	-	-
I	de 0,5 a 6A	0,2	-	-	-	-
In, Inc	de 0,5 a 6A	0,5	-	-	-	-
U	de 50 a 600V (fase/fase)	0,2	-	-	-	-
Pst, Plt	-	-	-	-	-	-
Udip	-	-	-	-	-	-
Uswl	-	-	-	-	-	-
Uint	-	-	-	-	-	-
Unba	-	-	-	-	-	-
Unb	-	-	-	-	-	-
Uh	-	-	-	-	-	-
Ih	-	-	-	-	-	-
Msv	-	-	-	-	-	-

CAIXA	
Dimensões:	96x96x60 ou 80 com todos os módulos de opções (DIN 43700)
Ligação	a partir de blocos descartáveis 2,5 mm ² (tensões e outras) e fixas 6 mm ² (correntes)
Índice de protecção:	Face dianteira IP52 e caixa IP30
Peso:	400 gr
VISUALIZADOR	
Type :	LCD com retroiluminação
MEDIDAS	
Rede trifásica (3 ou 4 fios), bifásica (2 fios) e monofásica	
TENSÃO (TRMS)	
Medida directa:	Fase/fase de 50 a 500 V AC - Fase/neutro de 28 a 289V AC
Sobrecarga permanente:	800 V AC
Período de actualização:	1 segundo
CORRENTE (TRMS)	
A partir do transformador de corrente com um:	• Primário até 9 999 A • Secundário 5 A
Corrente mínima de medida	5 mA
Consumo das entradas:	< 0,6 VA
Visualização	de 0 a 11 kA (1, prima 1 vez o valor do primário)
Sobrecarga permanente:	6 A
Sobrecarga intermitente:	10 In durante 1 segundo
Período de actualização:	1 segundo
POTÊNCIAS	
Totais:	de 0 a 11 MW/Mvar/MVA
Período de actualização:	1 segundo
FREQUÊNCIA	
Período de actualização:	de 45,0 a 65,0 Hz
Período de actualização:	1 segundo
ALIMENTAÇÃO AUXILIAR IEC/CE	
110 a 400 V AC	em 50/60 Hz ± 10 %
120 a 350 V DC	± 20 %
Consumo	< 10 VA

Caractéristiques techniques - Technische Daten - Technical characteristics -
 Caratteristiche tecniche - Technische eigenschappen - Características técnicas - Características técnicas

ACCURACY

Exactidão na energia activa :	IEC 62053-22 classe 0,5S
Exactidão na energia reactiva :	IEC 62053-23 classe 2

MARCAÇÃO CE

The SM102E product complies with :

- The requirements of the European directive on electromagnetic compatibility (EMC) no. 89/336/CEE dated 3 May 1989, modified by directive no. 92/31/CEE dated 28 April 1992 and by directive no. 93/68/CEE dated 22 July 1993.
- Low voltage directive no. 73/23/CEE dated 19 February 1973, modified by directive no. 93/68/CEE dated 22 July 1993, modified by directive no. 2006/95/CE.

COMPATIBILIDADE ELECTROMAGNÉTICA

Immunity to electrostatic discharges:	IEC 61000-4-2 - Level III
Immunity to radiated radio-frequency fields:	IEC 61000-4-3 - Level III
Immunity to electrical fast transients/bursts:	IEC 61000-4-4 - Level III
Immunity to surge immunity:	IEC 61000-4-5 - Level III
Immunity to conducted disturbances:	IEC 61000-4-6 - Level III
Immunity to power frequency magnetic fields:	IEC 61000-4-8 - Level III
Conducted and radiated emissions:	CISPR11 - Class A
Immunity to voltage dips and short interruptions:	IEC 61000-4-11

CLIMA

Operating-temperature range:	IEC 60068-2-1/IEC 60068-2-2: -10 °C to +55 °C
Storage temperature range:	IEC 60068-2-1/IEC 60068-2-2: -20 °C to +85 °C
Humidity:	IEC 60068-2-30 - 95 %
Salt mist:	IEC 60068-2-52 - 2,5 % NaCl

CARACTERÍSTICAS MECÂNICAS

Vibration from 10 to 50 Hz :	IEC 60068-2-6 - 2 g
------------------------------	---------------------

ISOLAÇÃO

Installation category:	III (480 VAC ph /ph)
Degree of pollution:	2
Rated impulse withstand voltage:	IEC 60947-1 - V imp: 4 kV
Front face:	Class II
Electric safety:	IEC 61010-1

CONFORMIDADE IEC 61557-12 EDITION 1 (08/2007)

CARACTERÍSTICAS DOS PMD

Tipo de características	Exemplos de valores característicos possíveis	Outras características complementares
Função (eventual) de avaliação da qualidade da alimentação	-	-
Classificação dos PMD	SD	-
Temperatura	K55	-
Humidade + Altitude	-	-
Classe de desempenho de funcionamento da potência activa ou da energia activa (se a função estiver disponível)	0,5	-

CARACTERÍSTICAS DAS FUNÇÕES

Símbolo das funções	Intervalo de medição	Classe de desempenho de funcionamento, em conformidade com a norma IEC 61557-12				Outras características complementares
		1000	100	10	1	
KI		1000	100	10	1	
P	-	0,5	-	-	2	de -90° a 90°
Qa, Qv	-	1	-	-	2	-
Sa, Sv	-	1	-	-	-	-
Ea	de 0 a 999999999 kW/h	0,5	-	-	-	de 0,02 a 1,2 In com PF = 0,5L ou 0,8C
Era, Erv	de 0 a 999999999 kVar/h	2	-	-	-	de 0,1 a 1,2 In com sin φ = 0,5L ou C
Eapa, Eapv	de 0 a 999999999 kW/h	0,5	-	-	-	-
f	de 45 a 65Hz	0,1	-	-	-	-
I	de 0,5 a 6A	0,2	-	-	-	de 10 a 110% de In
In, Inc	de 0,5 a 6A	0,5	-	-	-	de 10 a 110% de In
U	de 50 a 600V (fase/fase)	0,2	-	-	-	-
PFa, PFv	-	0,5	-	-	-	para 0,5<PF<1
Pst, Pit	-	-	-	-	-	-
Udip	-	-	-	-	-	-
Uswl	-	-	-	-	-	-
Utr	-	-	-	-	-	-
Uint	-	-	-	-	-	-
Unba	-	-	-	-	-	-
Unb	-	-	-	-	-	-
Uh	de 50 a 600V (fase/fase)	1	-	-	-	-
THDu	de 50 a 600V (fase/fase)	1	-	-	-	-
THD - Ru	-	-	-	-	-	-
Ih	de 0,5 a 6A	1	-	-	-	-
THDi	de 0,5 a 6A	1	-	-	-	-
THD_Ri	-	-	-	-	-	-
Msv	-	-	-	-	-	-

CARACTERÍSTICAS DAS “FUNÇÕES DE AVALIAÇÃO DA QUALIDADE DA ALIMENTAÇÃO”

Símbolo das funções	Intervalo de medição	Classe de desempenho de funcionamento, em conformidade com a norma IEC 61557-12				Outras características complementares
		1000	100	10	1	
KI		1000	100	10	1	-
f	de 45 a 65Hz	0,1	-	-	-	-
I	de 0,5 a 6A	0,2	-	-	-	-
In, Inc	de 0,5 a 6A	0,5	-	-	-	-
U	de 50 a 600V (fase/fase)	0,2	-	-	-	-
Pst, Plt	-	-	-	-	-	-
Udip	-	-	-	-	-	-
Uswl	-	-	-	-	-	-
Uint	-	-	-	-	-	-
Unba	-	-	-	-	-	-
Unb	-	-	-	-	-	-
Uh	-	-	-	-	-	-
Ih	-	-	-	-	-	-
Msv	-	-	-	-	-	-

nEt	Type de réseau
4NBL	Réseau triphasé non équilibré, 4 fils avec 3 ou 4 TC
4BL	Réseau triphasé équilibré, 4 fils avec 1 TC
3NBL	Réseau triphasé non équilibré, 3 fils avec 2 ou 3 TC
3BL	Réseau triphasé équilibré, 3 fils avec 1 TC
2BL	Réseau biphasé, 2 fils avec 1 TC
1BL	Réseau monophasé, 2 fils avec 1 TC
Ct	Transformateur de courant
MAX	Valeurs maximales moyennes
tIME 4I	Temps d'intégrations des valeurs maximales en courant
tIME P	Temps d'intégrations des valeurs maximales en puissances
rSET	Reset
MAX P	Valeur maximale de la puissance active moyenne
EA	Energie active (kWh)
ER	Energie réactive (kvarh)
AUX	Alimentation auxiliaire
bACLIt	Démarrage du rétro éclairage sur présence U ou I ou Aux
≡	Numéro de série
SOft	Version logicielle
THD I1, I2, I3	Taux de distorsion harmonique des courants
THD U12, U23, U31	Taux de distorsion harmonique des tensions composées
THD V1, V2, V3	Taux de distorsion harmonique des tensions simples

nEt	Netzart
4NBL	Dreiphasennetz mit ungleicher Belastung, 4 Leiter mit 3 oder 4 Stromwandler
4BL	Dreiphasennetz mit gleicher Belastung, 4 Leiter mit 1 Stromwandler
3NBL	Dreiphasennetz mit ungleicher Belastung, 3 Leiter mit 2 oder 3 Stromwandler
3BL	Dreiphasennetz mit gleicher Belastung, 3 Leiter mit 1 Stromwandler
2BL	Zweiphasennetz , 2 Leiter mit 1 Stromwandler
1BL	Einphasennetz, 2 Leiter mit 1 Stromwandler
Ct	Stromwandler
MAX	Maximale Durchschnittswerte
tIME 4I	Integrationszeit der Maximalwerte des Stroms
tIME P	Integrationszeit der Maximalwerte der Leistungs
rSET	Reset
MAX P	Maximalwert der Mittelwerte der Wirkleistung
EA	Wirkenergie (kWh)
ER	Blindenergie (kvarh)
AUX	Hilfsspannung
bACLIt	Parametrierung der Hintergrundbeleuchtung wahlweise auf U oder I oder Aux
≡	Serien-Nr.
SOft	Softwareversion
THD I1, I2, I3	Klirrfaktor der Ströme
THD U12, U23, U31	Klirrfaktor der verketteten Spannungen
THD V1, V2, V3	Klirrfaktor der unverketteten Spannungen

nEt	Network type
4NBL	Unbalanced three-phase network, 4 wires with 3 or 4 TC
4BL	Balanced three-phase network, 4 wires with 1 TC
3NBL	Unbalanced three-phase network, 3 wires with 2 or 3 TC
3BL	Balanced three-phase network, 3 wires with 1 TC
2BL	Two-phase network, 2 wires with 1 TC
1BL	Single-phase network, 2 wires with 1 TC
Ct	Current transformers
MAX	Maximum mean value
tIME 4I	Integration times for maximum current values
tIME P	Integration times for maximum power values
rSET	Reset
MAX P	Active power maximum mean value
EA	Active power (kWh)
ER	Reactive power (kvarh)
AUX	Auxiliary supply
bACLIt	LCD start-up (U or I or Aux. Condition)
≡	Serial number
SOft	Software version
THD I1, I2, I3	Current harmonic distortion rate
THD U12, U23, U31	Phase-to-phase voltage distortion rate
THD V1, V2, V3	Phase-to-neutral voltage distortion rate



nEt	Tipo di rete
4NBL	Rete trifase NON equilibrata , 4 fils con 3 o 4 TC
4BL	Rete trifase equilibrata, 4 fili con 1 TC
3NBL	Rete trifase NON equilibrata , 3 fili con 2 o 3 TC
3BL	Rete trifase equilibrata, 3 fili con 1 TC
2BL	Rete bifase, 2 fili con 1 TC
1BL	Rete monofase, 2 fili con 1 TC
Ct	Trasformatore di corrente
MAX	Massimi valori medi
tIME 4I	Tempo d'integrazione per il calcolo delle correnti max.
tIME P	Tempo d'integrazione per il calcolo delle potenze max.
rSET	Reset
MAX P	Massima potenza attiva media
EA	Energia attiva (kWh)
ER	Energia reattiva (kvarh)
AUX	Alimentazione ausiliaria
bACLIt	Retroilluminazione associata alla presenza tensione, corrente o alimentazione ausiliaria
≡	Numero di serie
SOft	Versione software
THD I1, I2, I3	THD% delle correnti di fase
THD U12, U23, U31	THD% delle tensioni concatenate
THD V1, V2, V3	THD% delle tensioni di fase

nEt	Netwerktipe
4NBL	Onevenwichtig driefasennet, 4 draden met 3 of 4 TC
4BL	Evenwichtig driefasennet, 4 draden met 1 TC
3NBL	Onevenwichtig driefasennet, 3 draden met 2 of 3 TC
3BL	Evenwichtig driefasennet, 3 draden met 1 TC
2BL	Tweefasennet, 2 draden met 1 TC
1BL	Enkelfasennet, 2 draden met 1 TC
Ct	Stroomtransformator
MAX	Maximale gemiddelde waarden
tIME 4I	Integratietijden maximale waarden stroom
tIME P	Integratietijden maximale waarden vermogen
rSET	Reset
MAX P	Maximale waarde gemiddeld actief vermogen
EA	Actieve energie (kWh)
ER	Reactieve energie (kvarh)
AUX	Hulpvoeding
bACLIt	Achtergrondverlichting aan bij aanwezigheid U of I of Aux
≡	Serienummer
SOft	Softwareversie
THD I1, I2, I3	Harmonische vervormingsfactor stromen
THD U12, U23, U31	Harmonische vervormingsfactor samengestelde spanningen
THD V1, V2, V3	Harmonische vervorming enkelvoudige spanningen

nEt	Tipo de red
4NBL	Red trifásica desequilibrada, 4 hilo con 3 o 4 TC
4BL	Red trifásica equilibrada, 4 hilo con 1 TC
3NBL	Red trifásica desequilibrada, 3 hilo con 2 o 3 TC
3BL	Red trifásica equilibrada, 3 hilo con 1 TC
2BL	Red bifásica, 2 hilo con 1 TC
1BL	Red monofásica , 2 hilo con 1 TC
Ct	Transformador de intensidad
MAX	Valores máximos medios
tIME 4I	Tiempo de integración de los valores máximos en intensidad
tIME P	Tiempo de integración de los valores máximos en potencias
rSET	Reset
MAX P	Valor máximo de la potencia activa media
EA	Energía activa (kWh)
ER	Energía reactiva (kvarh)
AUX	Alimentación auxiliar
bACLIt	Configuración de la retroiluminación sobre presencia U o I o Alim. Aux.
≡	Número de serie
SOft	Versión de software
THD I1, I2, I3	Grado de distorsión armónico (thd) de las intensidades
THD U12, U23, U31	Grado de distorsión armónico (thd) de las tensiones compuestas
THD V1, V2, V3	Grado de distorsión armónico (thd) de las tensiones simples

nEt	Tipo de rede
4NBL	Rede trifásica desequilibrada, 4 fios com 3 ou 4 TC
4BL	Rede trifásica equilibrada, 4 fios com 1 TC
3NBL	Rede trifásica desequilibrada, 3 fios com 2 ou 3 TC
3BL	Rede trifásica equilibrada, 3 fios com 1 TC
2BL	Rede bifásica, 2 fios com 1 TC
1BL	Rede monofásica, 2 fios com 1 TC
Ct	Transformador de corrente
MAX	Valores máximos médios
tIME 4I	Tempos de integrações dos valores máximos em corrente
tIME P	Tempos de integrações dos valores máximos em potências
rSET	Reset
MAX P	Valor máximo da potência activa média
EA	Energia activa (kWh)
ER	Energia reactiva (kvarh)
AUX	Alimentação auxiliar
bACLIt	Início da retro iluminação em presença de U ou I ou Aux
≡	Número de série
SOft	Versão do software
THD I1, I2, I3	Grau de distorção harmónica das correntes
THD U12, U23, U31	Grau de distorção harmónica das tensões compostas
THD V1, V2, V3	Grau de distorção harmónica das tensões simples

Hager SAS
132 Boulevard d'Europe
BP 78
F-67212 OBERNAI CEDEX
www.hager.fr



538030A